



State of Wisconsin \ Department of Commerce

RULES IN FINAL DRAFT FORM

Rule No.: Chapters Comm 20-25

Relating to: Uniform (1-2 Family) Dwelling Code

Clearinghouse Rule No.: 08-043

The Wisconsin Department of Commerce proposes an order to repeal ss. Comm 20.05 (4), Comm 20.07 (29m), Comm 20.07 (52), Comm 20.24 Table 20.24-4, Comm 20.24 Table 20.24-10, Comm 21.02 (1) (c) 2. and 3. and note, Comm 21.03 (8) and (9), Comm 21.05 (3) and (4), Comm 21.08 (1) (a) 4., Comm 21.10 (2) (g), Comm 21.10 (4) (b), Comm 21.22 (1m), Comm 21.22, Table 21.22-C, Comm 21.25 (1) (b), Comm 21.26, Tables 21.26-B and B1, and Comm 21.26 (5) (c);

to renumber ss. Comm 20.05 (5) to (9), Comm 20.24 Table 20.24-5, Comm 20.24 Tables 20.24-7 to 20.24-9, Comm 21.02 (1) (c) 1., Comm 21.02 (3) (a) to (e), Comm 21.03 (10) to (12), Comm 21.045 (1) to (4), Comm 21.05 (5), Comm 21.08 (1) (c), Comm 21.10 (2) (c) to (f), Comm 21.10 (4) (a), Comm 21.10 (3) and (4), Comm 21.15 (1) and (2) and 21.15 (intro.), Comm 21.17 (3) (d) 1. to 6., Comm 21.22 (3) (a) and (b) and 21.22 (3) (intro.), Comm 21.24 (3) (c), Comm 21.25 (1) (a), Comm 21.25 (6) (a) 4., Comm 21.26 (3) (a) 21.26 (3) (intro.), Comm 23.02 (3) (a), Comm 23.04 (4) and 23.04 (1) to (3);

to renumber and amend ss. Comm 20.24 Table 20.24-6, Comm 21.02 (3) (intro.), Comm 21.045 (intro.), Comm 21.08 (1) (c), and Comm 23.04 (intro.);

to amend ss. Comm 20.02 (2) (e), Comm 20.05 (6), Comm 20.13 (2), 20.14 (1), 20.14 (2) (a) 2. and 20.14 (2) (b) 2., Comm 20.24, Table 20.24-1, Table 20.24-2 line 1, and Table 20.24-3, Comm 20.24 Table 20.24-8 and Table 20.24-9, Comm 20.24 Table 20.24-11, Comm 20.24 Table 20.24-13, Comm 21.02 (3) (title), Comm 21.02 (3) (e), Comm 21.03 (title), Comm 21.03 (6) (e) 5., Comm 21.04 (2) (c) 2. and 21.04 (2) (c) 3. b., Comm 21.04 (3) (c) 1., Comm 21.05 (title), Comm 21.08 (intro.) and Table 21.08, Comm 21.08 (2) (c), Comm 21.09 (1) (b), 21.09 (2) and 21.09 (3), Comm 21.10 (2) (e), 21.10 (2) (f) 1. and 21.10 (2) (g), Comm 21.10 (2) (i), Comm 21.15 (1), Comm 21.15 (2) (a) Note, Comm 21.15 (2) (b), Comm 21.15 (2) (e), Comm 21.17 (1) (a) 2. and 21.17 (1) (b) 2., Comm 21.17 (3) (d) 6., Comm 21.18 (1) (d) 2.b., Comm 21.18 Tables 21.18-C, D, E and F, footnote a, Comm 21.22 (8) (b), Comm 21.24 (2), Comm 21.25 (1) (title), Comm 21.26 (3) (a), Comm 21.26 (4) (b), Comm 21.26 (7) (a) 2., Comm 21.40 (2) (b) 13., Comm 23.02 (3) (d), Comm 23.04 (4), Comm 23.045 (2) (b), and Comm 23.09 (1);

to repeal and recreate ss. Comm 20.02 (1), Comm 20.04 (2) and (5), Comm 20.09 and 20.10, Comm 21.03 (3), Comm 21.03 (7), Comm 21.04 (1), Comm 21.05 (3) (a) and 21.05 (3) (b), Comm 21.08 (1) (d) 1., Comm 21.10 (2) (b), Comm 21.10 (2) (h), Comm 21.18 (3) (a), Comm 21.18 (4) and 21.22 (1), Comm 21.25 Table 21.25-A, Comm 21.26 (1), Comm 21.26 (5) (a), Comm 21.26 (8) and 21.26 (12), Comm 21.27 and 21.28, Comm 23.08 (7), and Comm 23.08, Table 23.08-B;

and to create ss. Comm 20.04 (6), Comm 20.05 (9), Comm 20.065, 20.07 (5m), 20.07 (18) and 20.07 (24v), Comm 20.07 (34s), Comm 20.07 (53f) and (77f), Comm 20.24 Table 20.24-6, Comm 20.24 Table 20.24-7, Comm 20.24 Table 20.24-12, Comm 21.02 (3) (b) 3., Comm 21.02 (3) (g), Comm 21.035, Comm 21.04 (2) (c) 3. c. and 4. c., Comm 21.04 (2) (g) and 21.04 (3) (a) 2. Note, Comm 21.04 (3) (a) 3. c., Comm 21.045 Note, Comm 21.05 (3) Note, Comm 21.08 (1) (c) 2., Comm 21.09 (6), Comm 21.095, Comm 21.10 (1) and 21.10 (2) (a), Comm 21.10 (2) (c), Comm 21.10 (2) (k), Comm 21.10 (3), Comm 21.10 (6) and 21.11 Note, Comm 21.17 (3) (d) 1., Comm 21.18 (1) (d) 1. Note, Comm 21.18 (2) (a) (title), 21.18 (2) (b) (title) and 21.18 (2) Note, Comm 21.22 (3) (d), Comm 21.24 (3) (c), 21.24 (3) Note and 21.24 (4), Comm 21.25 (6) (a) 4. and 21.25 (7), (8) and (9), Comm 21.26 (7) (a) 5. to 7., Comm 21.26 (7) (c), Comm 23.02 (3) (a) 2., and Comm 23.04 (5).

.....

ANALYSIS OF PROPOSED RULES

1. Statutes Interpreted:

Sections 101.02 (1), 101.63 (1), 101.64 (3), 101.72 and 101.74, Stats.

2. Statutory Authority:

Sections 101.02 (1), 101.63 (1), 101.64 (3), 101.72 and 101.74, Stats.

3. Related Statute or Rule:

Sections 101.63 (5) and 101.73 (8), Stats.

4. Explanation of Agency Authority:

Under the statute sections listed above, the Department of Commerce has the responsibility to adopt rules that establish uniform, statewide standards for the construction of 1- and 2-family dwellings. This code, in its entirety, first went into effect in 1980. Sections 101.63 (5) and 101.73 (8), Stats., require the department to review these rules on a biennial basis.

5. Summary of Proposed Rules:

The vast majority of these proposed rule changes are intended to clarify current policies and requirements. The substantial changes to the code are as follows:

- Sections Comm 20.02 (1), 20.09 and 20.10 relating to scope of the code, permit issuance and inspections, respectively, have been reformatted and expanded.
- Section Comm 20.24 on adopted national standards is updated to include the latest editions. One standard on duct construction is dropped and two new ones on fire sprinkler construction and log home construction are added.
- Section Comm 21.24 (4) has new requirements for water-resistive barriers under the exterior covering of the dwelling.
- Section Comm 21.25 (7) has new requirements for the construction of short "cripple walls" on top of foundation walls.
- Sections Comm 21.25 (8) and (9) has new requirements for wind bracing of wood frame walls that bring the Wisconsin requirements in line with national standards.
- Chapter Comm 22, containing the energy conservation requirements, is repealed and recreated to bring the Wisconsin requirements in line with the national model energy code. There are new prescriptive component requirements as an alternative to the traditional total envelope heat loss requirements.

6. Summary of, and Comparison with, Existing or Proposed Federal Regulations:

There appear to be no federal regulations governing general one- and 2-family dwelling construction.

7. Comparison to Rules in Adjacent States:

An Internet search of the State of Illinois' website did not reveal the existence of a statewide one- and 2-family dwelling code. Dwelling regulation appears to be left up to the individual local units of government.

An Internet search of the State of Iowa's website did not reveal the existence of a statewide one- and 2-family dwelling code. Dwelling regulation appears to be left up to the individual local units of government.

An Internet search of the State of Michigan's website showed a mandatory, statewide one- and 2-family dwelling code. The Residential Construction Code under the Construction Code Commission General Rules, section 408.305, contains the state amendments to the 2006 International Residential Code (IRC) developed by the International Code Council (ICC). There is a separate energy code.

An Internet search of the State of Minnesota's website showed a mandatory, statewide one- and 2-family dwelling code. Minnesota Department of Labor and Industry, Chapter 1309 adopts the 2006 International Residential Code (IRC), chapters 2-10 and 43. Chapters 2-10 contain the general construction provisions of the IRC. Separate state codes apply to the energy, mechanical, plumbing, electrical and flood protection provisions of dwelling construction.

8. Summary of Factual Data and Analytical Methodologies:

The department received input at regular quarterly meetings during the entire development cycle from the Uniform Dwelling Code Council. The makeup of this Council is set under s. 15.157 (3), Stats. The members are appointed by the Governor's Office. The Council's composition reflects a variety of organizations whose members include many types of small businesses. Through this Council, the department is able to gather information on the potential impacts of the administrative and technical requirements of the code.

For the majority of this development cycle, the UDC Council was comprised of:

Allan Bachmann, Madison, Bachmann Construction;
Jeffrey Bechard, Eau Claire, Sheet metal Workers Local 18;
Ken Dentice, City of La Crosse Building Inspection;
David Dolan-Wallace, Green Bay, Martinson Architects;
Tom Doleschy, Muskego, Chicago Regional Council of Carpenters;
Dan Gorski, Madison, Veridian Homes;
Robert Jakel, City of Kaukauna;
Steven Levine, Madison, Wisconsin Public Service Commission;
Mike Mueller, Milwaukee, International Brotherhood of Electrical Workers Local 494;
Daniel Nowak, City of Oak Creek Building Inspection;
Frank Opatik, Wausau, Wausau Homes;
Tom Palecek, Marshfield, Wick Building Systems;
Gary Ruhl, Oshkosh, NE Wisconsin Building & Construction Trades Council;
Mary Schroeder, Brookfield, Miller Homes;
Katy Stadtherr, City of Green Bay Building Inspection;
John Vande Castle, Fond du Lac, Fond du Lac Mosaic Tile Company, Inc.; and
Mike Wallace, City of Hudson Building Inspection

9. Analysis of Supporting Documents Used to Determine Effect on Small Business or in Preparation of Economic Impact Report:

These proposed rules do not significantly impact small businesses. The proposed rules do adopt more current technical design and construction standards used by designers and various tradespersons but those standards do not have a significant impact. The proposed rules do enhance the wind bracing requirements resulting in increase material and labor costs that would be passed on to the consumer. The design, material, and labor costs for the proposed specified methods of wind bracing are estimated to be \$360 or 0.15% for an 1800 square foot, two-story home valued at \$250,000 and \$100 or 0.06% for a 1200 square foot, single story home valued at \$180,000. The proposed rules will add an additional insulation requirement beneath a heated slab in contact with earth regardless of the depth below grade. Such heated slabs are allowed but not required by the code. For those homes that utilize this heated slab construction the added cost would be in the range of \$.75 per square foot. For an 1800 square foot, two-story home with a 900 square feet heated basement floor the cost increase would be \$675, or three tenths of one percent for a home valued at \$250,000.

10. Agency Contact:

Duane Hubeler, UDC Consultant, duane.hubeler@wi.gov, (608) 266-1390

11. Public Hearing Comments:

The hearing record on this proposed rulemaking will remain open until July 7, 2008. Written comments on the proposed rules may be submitted to Duane Hubeler, at the Department of Commerce, P.O. Box 2658, Madison, WI 53701-2658, or e-mail to duane.hubeler@wi.gov

SECTION 1. Comm 20.02 (1) is repealed and recreated to read:

Comm 20.02 (1) GENERAL. The provisions of this code apply to all of the following:

(a) All one- and two-family dwellings built on or after the effective dates under s. Comm 20.03.

Note: This includes site-built dwellings, manufactured buildings used as dwellings, modular homes and dwellings that may be designated as cabins, seasonal homes, temporary residences, etc., (except for manufactured or HUD homes, which are covered separately under this section).

(b) Adult family homes providing care, treatment and services for 3 or 4 unrelated adults built on or after the effective dates under s. Comm 20.03.

(c) Community-based residential facilities providing care, treatment and services for 5 to 8 unrelated adults built on or after the effective dates under s. Comm 20.03.

(d) The onsite installation of a mobile home or manufactured home on piers, regardless of the date of production of the home.

Note: The design and construction of a manufactured home is regulated by the U.S. Department of Housing and Urban Development and is not subject to UDC requirements. Prior to regulation by HUD in 1976, manufactured homes were known as mobile homes and their design and construction were not uniformly regulated. See s. Comm 20.07 (52m) for the statutory definition.

(e) The onsite installation of a manufactured home, regardless of the type of foundation, where the manufactured home has a production date on or after April 1, 2007.

(f) The design and construction of a crawlspace, basement or foundation, other than piers, under a manufactured home where the manufactured home has a production date on or after the effective dates under s. Comm 20.03.

(g) All garages, carports, porches, stoops, decks, balconies, stairways and similar structures that are attached to any building covered under this section that was constructed or had a production date on or after the effective dates under s. Comm 20.03.

(h) Adjacent, unattached structures listed under par. (g) that serve an exit from a dwelling.

SECTION 2. Comm 20.02 (2) (e) 1. is amended to read:

Comm 20.02 (2) (e) 1. Implementing erosion and sediment control requirements that are more stringent than the standards of this ~~chapter~~ code when directed by an order of the United States Environmental Protection Agency or by an administrative rule of the department of natural resources under s. NR 151.004.

SECTION 3. Comm 20.04 (2) and (5) are repealed and recreated to read:

Comm 20.04 (2) ADDITIONS AND ALTERATIONS. Additions and alterations to dwellings covered by this code shall comply with all provisions of this code at the time of permit application or the beginning of the project, if no permit is required.

Comm 20.04 (5) REUSE OF A DWELLING OR FOUNDATION. (a) *Existing dwelling or manufactured home placed on a different foundation.* Where an existing dwelling or manufactured home is placed on a different foundation, the new foundation is considered an addition or alteration to the existing dwelling or manufactured home.

Note: The applicability of this code to an addition or alteration to an existing dwelling or manufactured home is determined by the original date of construction of the dwelling or manufactured home and is not altered by any movement of the structure.

(b) *New dwelling or manufactured home.* A new dwelling or manufactured home placed on a new or existing foundation shall meet the permitting, construction and inspection requirements of a new dwelling or manufactured home.

SECTION 4. Comm 20.04 (6) is created to read:

Comm 20.04 (6) SEPARATED BUILDINGS. For a building to be considered a separate single-family dwelling or a separate two-family dwelling within the scope of this code, regardless of ownership or occupancy arrangements, all of the following conditions shall be met:

(a) No structural members other than a common footing may be shared between any 2 dwellings.

Note: Two separated, insulated foundation walls may share the same structural footing.

(b) The adjoining exterior walls of the separate dwellings shall each have exterior coverings meeting the requirements of s. Comm 21.24.

(c) The adjoining exterior walls, including foundations, of the separate dwellings shall each meet the energy requirements under ch. Comm 22, irrespective of any adjacent dwelling.

(d) Both sides of any 2 adjoining walls, floors, ceilings and attics between dwellings shall meet the dwelling separation requirements of s. Comm 21.08 (1) for 2 dwellings on the same property less than 5 feet apart.

Notes:

1. Flashing is acceptable to connect the roofs between dwelling units. See appendix for further information.

2. A building of 3 or more dwelling units without the separations specified in this section is a commercial building and shall meet the requirements set forth in chs. Comm 60 to 66.

SECTION 5. Comm 20.05 (4) is repealed.

SECTION 6. Comm 20.05 (5) to (9) are renumbered Comm 20.05 (4) to (8).

SECTION 7. Comm 20.05 (6), as renumbered, is amended to read:

Comm 20.05 (6) FARM BUILDINGS. The provisions of this code do not apply to the buildings used exclusively for farm operations and not for human habitation.

SECTION 8. Comm 20.05 (9) is created to read:

Comm 20.05 (9) MOTOR HOMES AND RECREATIONAL VEHICLES. The provisions of this code do not apply to motor homes and recreational vehicles that are, or have been, titled through the department of transportation.

Note 1: Section 340.01 (33m) and (48r), Stats., read as follows: “Motor home” means a motor vehicle designed to be operated upon a highway for use as a temporary or recreational dwelling and having the same internal characteristics and equipment as a mobile home.

“Recreational vehicle” means a vehicle that is designed to be towed upon a highway by a motor vehicle, that is equipped and used, or intended to be used, primarily for temporary or recreational human habitation, that has walls of rigid construction, and that does not exceed 45 feet in length.

Note 2: A "park model" is a recreational vehicle.

SECTION 9. Comm 20.065 is created to read:

Comm 20.065 State jurisdiction. (1) In accordance with s. 101.64 (8), Stats., municipalities administering the code may be monitored by the department for compliance with the administrative requirements under this code.

(2) In accordance with s. 101.653 (5), Stats., municipalities administering the code may be audited by the department for compliance with the erosion control requirements under this code.

SECTION 10. Comm 20.07 (5m), and Comm 20.07 (18) are created to read:

Comm 20.07 (5m) “Attached,” defining the relationship between another building and a dwelling, means at least one of the following conditions is present:

(a) There is a continuous, weatherproof roof between the two structures.

Note: The sides are not required to be enclosed with walls.

(b) There is a continuous, structural floor system between the two structures.

(c) There is a continuous foundation system between the two structures.

Comm 20.07 (18) “Common use area” means kitchens, hallways, basements, garages and all habitable rooms.

Note: These areas must meet the circulation requirements under s. Comm 21.03 (8).

SECTION 11. Comm 20.07 (29m) is repealed.

SECTION 12. Comm 20.07 (34s) is created to read:

Comm 20.07 (34s) “Foundation” means the structural system used to transfer the weight of the building to the earth.

Note: The foundation may include one or more components such as footings, piers, columns, slabs and walls.

SECTION 13. Comm 20.07 (52) is repealed.

SECTION 14. Comm 20.07 (53f) and (77f) are created to read:

Comm 20.07 (53f) “Modular home” has the meaning given in s. 101.71 (6), Stats.

Note: Under s. 101.71 (6) (a), Stats., “ modular home” means any structure or component thereof which is intended for use as a dwelling and:

1. Is of closed construction and fabricated or assembled on-site or off-site in manufacturing facilities for installation, connection, or assembly and installation, at the building site; or

2. Is a building of open construction which is made or assembled in manufacturing facilities away from the building site for installation, connection, or assembly and installation, on the building site and for which certification is sought by the manufacturer.

(b) “ Modular home” does not mean any manufactured home under s. 101.91 or any building of open construction which is not subject to par. (a) 2.

Note: See s. Comm 20.07 (52m) for the definition of manufactured home.

Comm 20.07 (77f) “Water-resistive barrier” means a material, including flashing, behind an exterior wall covering that is intended to resist liquid water that has penetrated behind the permanent weather-resistant finish from further intruding into the exterior wall assembly.

SECTION 15. Comm 20.09 and 20.10 are repealed and recreated to read:

Comm 20.09 Procedure for obtaining uniform building permit. (1) APPLICATION. Application for a Wisconsin uniform building permit shall be on forms obtained from the

department, the municipality or the authorized UDC inspection agency administering and enforcing this code. No application shall be accepted that does not contain all the information requested on the form.

Note 1: See appendix for a copy of the Wisconsin uniform building permit and application.

Note 2: Any municipality exercising jurisdiction may require reasonable supplementary information not contained on the Wisconsin building permit application.

(2) FILING OF PERMIT APPLICATIONS. (a) *Construction or installation of a dwelling.* 1. A Wisconsin uniform building permit application for the construction or installation of a dwelling shall be filed with the municipality or the authorized UDC inspection agency administering and enforcing this code.

2. The municipality or authorized UDC inspection agency shall forward a copy of all applications for new dwellings to the department within 30 business days after permit issuance.

Note: The department requires copies of permits that are issued for new dwelling construction or installation, only. Permits issued for additions, alterations, garage construction, etc., should not be filed with the department.

(b) *Additions, alterations and repairs.* 1. When required by local ordinance, permit applications for additions, alterations and repairs shall be filed with municipalities and counties in accordance with their adopted ordinances.

Note: The Department of Commerce requires copies of permits that are issued for new dwelling construction only. Any permits issued for additions, alterations, repairs, garage construction, etc. are not required to be filed with the department.

2. Pursuant to s. 101.65 (1m), Stats., a building permit required under subd. 1. may not be issued unless the conditions of sub. (5) (c) are satisfied, except as provided under s. 101.654 (1) (b), Stats.

3. Building permits for additions, alterations and repairs are not required in municipalities where the department has jurisdiction under s. 101.651 (3) (b), Stats.

(c) *General requirements.* 1. The permit application shall be reviewed by a certified UDC inspector.

2. A permit may be issued only after approval of the requirements under this section by a certified UDC inspector.

3. Dwellings for which a permit has been issued shall be inspected in accordance with s. Comm 20.10.

(3) FEES. (a) *Municipal fees.* 1. The municipality shall, by ordinance, determine fees to cover expenses of plan examination, inspection and the issuance of the Wisconsin uniform building permit.

2. The municipality shall purchase a Wisconsin uniform building permit seal from the department for each new dwelling in accordance with s. Comm 2.34.

(b) *Inspection agency fees.* 1. UDC inspection agency fees shall be determined by contract between the municipality and the agency or between the department and the agency, where the agency has been authorized to conduct inspections on behalf of the department.

2. A UDC inspection agency shall purchase a Wisconsin uniform building permit seal from the department in accordance with s. Comm 2.34.

(4) **PLAN SUBMITTALS.** At least 2 sets of plans for all one- and 2-family dwellings shall be submitted to the municipality or authorized UDC inspection agency administering and enforcing this code, for examination and approval at the time the Wisconsin uniform building permit application is filed.

(5) **REQUIRED PLANS.** The required building plans shall be legible and drawn to scale or dimensioned and shall include all of the following:

(a) *Site plan.* The site plan shall show all of the following:

1. The location of the dwelling and any other buildings, wells, surface waters and dispersal systems on the site with respect to property lines and surface waters adjacent to the site.

2. The areas of land-disturbing construction activity and the location of all erosion and sediment control measures to be employed in order to comply with s. Comm 21.125.

3. The pre-construction ground surface slope and direction of runoff flow within the proposed areas of land disturbance.

(b) *Floor plan.* 1. Floor plans shall be provided for each floor.

2. The following features shall be included on all floor plans:

a. The size and location of all rooms, doors, windows, structural features, exit passageways and stairs.

b. The use of each room.

c. The location of plumbing fixtures, chimneys, heating and cooling appliances, and a heating distribution layout.

d. The location and construction details of the braced wall lines.

(c) *Elevations.* The elevations shall show all of the following:

1. The exterior appearance of the building, including the type of exterior materials.
2. The location, size and configuration of doors, windows, roof, chimneys, exterior grade, footings and foundation walls.

(d) *Storm water management plan.* 1. A storm water management plan shall be prepared for a site where one acre or more of land will be disturbed.

2. The storm water management plan shall delineate and describe the post-construction storm water management practices to be employed to comply with s. Comm 21.126.

(6) REQUIRED DATA. (a) All plans submitted for approval shall be accompanied by sufficient data, calculations and information to determine if the dwelling will meet the requirements of this code.

(b) The data and information for determining compliance with the energy conservation standards shall be submitted in a format approved by the department.

(c) Except as required under s. Comm 21.33, a municipality exercising jurisdiction may not require plans or calculations to be stamped or sealed by an architect or engineer.

(d) The name of the initial downstream receiving water of the state from the dwelling shall be identified, regarding erosion and sediment control and storm water management.

(7) MASTER PLANS. (a) Where a dwelling is intended to be identically and repetitively constructed at different locations, a master plan may be submitted for approval.

(b) The plans shall include plans and data as required under subs. (5) and (6).

(c) If the plans conform to the provisions of the code, an approval and a master plan number shall be issued.

(d) The number issued may be used in lieu of submitting building plans for each location.

(e) A plot plan shall be submitted for each location at the time of application for the Wisconsin uniform building permit.

(8) APPROVAL OF PLANS. (a) If the municipality or authorized UDC inspection agency administering and enforcing the code determines that the plans submitted for a one- or 2-family dwelling substantially conform to the provisions of this code and other legal requirements, an approval shall be issued.

(b) The plans shall be stamped “conditionally approved” by a certified inspector who holds the respective credential for the plans reviewed.

(c) One copy shall be returned to the applicant and one copy shall be retained by the municipality or authorized UDC inspection agency administering and enforcing this code.

(d) The conditions of approval shall be indicated by a letter or on the permit.

(e) All conditions of the approval shall be met during construction.

(9) ISSUANCE AND POSTING OF PERMITS. (a) *Uniform building permit.* 1. The Wisconsin uniform building permit shall be issued if the requirements for filing and fees are satisfied and the plans have been conditionally approved.

2. Pursuant to s. 101.65 (1m), Stats., a Wisconsin uniform building permit may not be issued to a person unless the person complies with subds. 3. and 4., except as provided under s. 101.654 (1) (b) and (c) 2., Stats.

Note 1: Section 101.654 (1) (b), Stats., exempts an owner of a dwelling who resides or will reside in the dwelling and who applies for a building permit to perform work on the dwelling from obtaining a dwelling contractor financial responsibility registration. Under s. 101.65 (1r), an owner who obtains a building permit needs to sign a statement advising the owner of the potential consequences of hiring a contractor to perform work under the permit who is not bonded or insured under s. 101.654 (2) (a), Stats.

Note 2: Section 101.654 (1) (c) 2., Stats., reads: “The continuing education requirements under par. (a) and the rules promulgated by the department under sub. (1m) do not apply to any person who holds a current license issued by the department at the time that the person obtains a building permit if the work the person does under the permit is work for which the person is licensed.”

3. A person applying for a Wisconsin uniform building permit for work covered under chs. Comm 21 or 22 who is not the owner who resides or will reside in the dwelling shall hold one of the following credentials issued by the department:

a. A dwelling contractor certification.

b. A dwelling contractor - restricted certification.

c. A dwelling contractor financial responsibility certification.

d. A dwelling contractor financial responsibility – restricted certification.

4. A person applying for a Wisconsin uniform building permit for work covered under chs. Comm 21 or 22 who is not the owner who resides or will reside in the dwelling shall hold or engage, as an employee, a person who holds a certification issued by the department as a dwelling contractor qualifier.

5. The permit shall expire 24 months after issuance if the dwelling exterior has not been completed.

6. Pursuant to s. 101.63 (7), Stats., the name and license number of the Wisconsin master plumber responsible for the installation of plumbing shall be entered on the permit by the issuing entity at the time of issuance.

(b) *Permit to start construction of footings and foundation.* 1. Construction may begin on footings and foundations prior to the issuance of the Wisconsin uniform building permit where a permit to start construction is obtained.

2. Upon submittal of the application for a permit to start construction, a plot plan, complete footing and foundation information including exterior grading, and a fee, the municipality or authorized UDC inspection agency enforcing this code may issue a permit to start construction of the footings and foundation.

3. The issuance of a permit to start construction shall not influence the approval or denial of the Wisconsin uniform building permit application.

(c) *Private onsite wastewater treatment systems.* Pursuant to s. 145.195, Stats., if the proposed construction requires connection to a private onsite wastewater treatment system, a Wisconsin uniform building permit may not be issued unless conformance with s. Comm 83.25 (2) has first been determined.

Note: See appendix for a reprint of s. Comm 83.25 (2).

(d) *Posting of permit.* 1. The Wisconsin uniform building permit shall be posted in a conspicuous place at the dwelling site.

2. The Wisconsin uniform building permit seal shall be affixed to the posted permit or to the Wisconsin uniform building permit application. The permit seal number shall appear on both documents.

(10) DISAPPROVAL OF PLANS AND DENIAL OF PERMITS. (a) *General.* Approval shall be denied if the municipality or authorized UDC inspection agency administering and enforcing this code determines that the Wisconsin uniform building permit application or the plans do not substantially conform to the provisions of this code and other legal requirements.

(b) *Denial of application.* A copy of the denied application, accompanied by a written statement specifying the reasons for denial, shall be sent to the applicant and to the owner as specified on the Wisconsin uniform building permit application.

(c) *Stamping of plans.* 1. Plans which do not substantially conform to the provisions of the code shall be stamped "not approved."

2. One copy shall be returned to the person applying for the Wisconsin uniform building permit and one copy shall be retained by the municipality or authorized UDC inspection agency administering and enforcing the code.

(d) *Appeals*. The applicant may appeal a denial of the application in accordance with the procedure outlined in s. Comm 20.21.

(11) TIME-SPAN FOR APPROVAL OR DENIAL. Action to approve or deny a uniform building permit application shall be completed within 10 business days of receipt of all forms, fees, plans and documents required to process the application, and completion of other local prerequisite permitting requirements.

Comm 20.10 Inspections. (1) INSPECTOR CERTIFICATION. All inspections, for the purpose of administering and enforcing this code, shall be performed by an inspector certified in accordance with ch. Comm 5 who holds the respective credential for the inspection performed.

(2) GENERAL INSPECTION REQUIREMENTS. (a) *General*. Inspections shall be conducted by the municipality or authorized UDC inspection agency administering and enforcing this code to determine if the construction or installations conform to the conditionally approved plans, the Wisconsin uniform building permit application and the provisions of this code.

(b) *Inspection notice*. 1. The applicant or an authorized representative shall request inspections from the municipality or authorized UDC inspection agency administering and enforcing this code.

2. Except as provided under subd. 3., construction may not proceed beyond the point of inspection until the inspection has been completed.

3. Construction may proceed if the inspection has not taken place by the end of the second business day following the day of notification or as otherwise agreed between the applicant and the municipality or authorized UDC inspection agency.

(3) INSPECTION TYPES. (a) *General*. The inspections described in pars. (b) to (I) shall be performed to determine if the work complies with this code.

(b) *Erosion control inspection*. Erosion control inspections shall be performed concurrently with all other required construction inspections. Additional inspections for erosion control may be performed by the delegated authority.

(c) *Foundation excavation inspection*. 1. The excavation for the foundation shall be inspected after the placement of any forms or required reinforcement and prior to the placement of the permanent foundation material.

2. If a drain tile system is required, by the local inspector or by groundwater levels in the excavation, the presence and location of bleeders used to connect the interior and exterior drain tile shall be inspected at the same time as the excavation.

Note: This excavation inspection may be used to determine the need for drain tile under s. Comm 21.17.

(d) *Foundation reinforcement inspection.* The placement of reinforcement shall be inspected where the reinforcement is required for code compliance.

(e) *Foundation inspection.* The foundation shall be inspected after completion. Where dampproofing, exterior insulation or drain tile are required for code compliance, the foundation shall be inspected prior to backfilling.

(f) *Rough inspection.* 1. A rough inspection shall be performed for each inspection category listed under subpars. a. to e. after the rough work is constructed but before it is concealed.

a. The basement floor area.

Note: The inspection of the basement floor area should include the following: any underfloor plumbing, electrical, or HVAC; any interior drain tile with base course required under s. Comm 21.17; the structural base course for the floor slab if required under s. Comm 21.20; and the underfloor vapor retarder as required under s. Comm 22.38.

b. General construction, including framing.

c. Rough electrical.

d. Rough plumbing.

e. Rough heating, ventilating and air conditioning.

2. All categories of work for rough inspections may be completed before the notice for inspection is given, provided the work has not been covered.

3. The applicant may request one rough inspection or individual rough inspections.

4. A separate fee may be charged for each individual inspection.

(g) *Insulation inspection.* An inspection shall be made of the insulation and vapor retarders after they are installed but before they are concealed.

(h) *Final inspection.* 1. Except as provided under subd. 2., the dwelling may not be occupied until a final inspection has been made that finds no critical violations of this code that could reasonably be expected to affect the health or safety of a person using the dwelling.

2. Occupancy may proceed in accordance with local ordinances if the inspection has not been completed by the end of the fifth business day following the day of notification or as otherwise agreed between the applicant and the department or municipality.

(i) *Installation inspection.* An inspection shall be performed on the installation of a manufactured dwelling or manufactured home.

Note: The design and construction of manufactured homes is regulated by the federal Department of Housing and Urban Development under Title 24 CFR Part 3280.

(4) NOTICE OF COMPLIANCE OR NONCOMPLIANCE. (a) *General.* 1. Notice of compliance or noncompliance with this code shall be written on the building permit or another readily visible means and posted at the job site.

2. Upon finding of noncompliance, the municipality or authorized UDC inspection agency enforcing this code shall also notify the applicant of record and the owner, in writing, of the violations to be corrected.

3. Except as specified under par. (b), the municipality or authorized UDC inspection agency shall order all cited violations corrected within 30 days after written notification, unless an extension of time is granted under s. Comm 20.21.

(b) *Erosion and sediment control requirements.* 1. The time period allowed for compliance with the erosion and sediment control provisions under s. Comm 21.125 shall be determined based on the severity of the noncompliance in relation to soil loss or potential damage to the waters of the state.

2. Pursuant to s. 101.653 (7) (b), Stats., the department, a municipality or the designated UDC inspection agency may issue a special order directing an immediate cessation of construction work on other aspects of the dwelling until compliance with the erosion and sediment control provisions under s. Comm 21.125 is attained. Construction work may resume once the erosion and sediment control compliance corrections are completed.

Note: Section 101.653 (7) (b) reads: "The department or a city, village, town or county may issue a special order directing the immediate cessation of work on a one- or 2-family dwelling until the necessary plan approval is obtained or until the site complies with the rules promulgated under sub. (2)."

(5) VOLUNTARY INSPECTION. The department or its authorized representative may, at the request of the owner or the lawful occupant, enter and inspect dwellings, subject to the provisions of this code, to ascertain compliance with this code.

(6) RECORD KEEPING. (a) *Municipal enforcement.* Municipalities that have adopted an ordinance to enforce this code shall maintain records in accordance with all of the following:

1. A record shall be made of each visit to a site, each inspection type performed and the pass or fail results of each inspection.

2. Approved plans shall be retained for 4 years after completion of the dwelling.

3. Applications forms, correction orders, correspondence and inspection records shall be maintained for 7 years after completion of the dwelling.

(b) *State enforcement.* Inspectors working under state contract shall maintain records in accordance with the provisions of the contract that was in effect at the time the inspections were completed.

Note: Records generated by the plan review and inspection functions are public records and are subject to the open-records law.

SECTION 16. Comm 20.13 (2), Comm 20.14 (1), Comm 20.14 (2) (a) 2., Comm 20.14 (2) (b) 2. and Comm 20.21 (1) (intro.) are amended to read:

Comm 20.13 (2) INSTALLATION. A Wisconsin uniform building permit shall be obtained in accordance with ~~the procedures outlined in s. Comm 20.09 (1), (2), (3) and (4) (a) 1. (1) to (5) (a)~~ before any on-site construction falling within the scope of this code is commenced for a ~~manufactured dwelling~~ modular home. The permit shall be issued in accordance with s. Comm 20.09 ~~(5) (9)~~.

Comm 20.14 (1) APPLICATION FOR APPROVAL. (a) An application for approval of any ~~manufactured dwelling~~ modular home, building system or component shall be submitted to the department in the form required by the department, along with the appropriate fees in accordance with s. Comm 2.34.

(b) ~~Pursuant to s. Comm 2.07 (3), the~~ The department shall review and make a determination on an application for approval of a ~~manufactured dwelling~~ modular home, building system or component within 3 months.

Comm 20.14 (2) (a) 2. ‘Compliance assurance program.’ a. Three sets of the compliance assurance program shall be submitted for examination and approval.

b. The compliance assurance program ~~submitted to the department on behalf of the manufacturer~~ shall meet the standards of the Model Documents for the Evaluation, Approval and Inspection of Manufactured Buildings as adopted under Table 20.24-9 10 or an equivalent as determined by standard acceptable to the department.

Comm 20.14 (2) (b) 2. ‘Compliance assurance program.’ a. Three sets of the compliance assurance program shall be submitted to the department ~~on behalf of the manufacturer~~ for examination and approval of components.

b. The compliance assurance program shall meet the requirements established by the department or, where applicable, be in the form of the ~~NBS "Model Rules and Regulations. Model Documents for the Evaluation, Approval and Inspection of Manufactured Buildings as adopted under Table 20.24-10~~ or an equivalent standard acceptable to the department.

Comm 20.21 (1) (intro.) APPEALS OF ORDERS AND DETERMINATIONS BY A MUNICIPALITY EXERCISING JURISDICTION. Appeals of order or determination of a municipality exercising jurisdiction under this code, including denials of application for permits,

shall be made in accordance with the procedure set out in ch. 68, Stats., prior to making an appeal to the department, except as follows:

SECTION 17. Comm 20.24 Table 20.24-1, Table 20.24-2, and Table 20.24-3 are amended to read:

Table 20.24-1

ACI	American Concrete Institute P.O. Box 9094 Farmington Hills, MI 48333
Standard Reference Number	Title
1. 318-99 <u>05</u>	Building Code Requirements for Structural Concrete
2. 530-99 <u>05</u>	Building Code Requirements for Masonry Structures
3. 530.1-99 <u>05</u>	Specification for Masonry Structures

Table 20.24-2

AF&PA	American Forest & Paper Association 1111 19 th Street, N.W., Suite 800 Washington, D.C. 20036
Standard Reference Number	Title
1. NDS- 2004 <u>2005</u>	National Design Specification For Wood Construction Including 2004 <u>2005</u> Supplement
2. Technical Report #7 January, 1987 <u>ANSI/AF&PA PWF - 2007</u>	The Permanent Wood Foundation System, Basic Requirements, except for section 3.3.1 <u>Permanent Wood Foundation Design Specification</u>

Table 20.24-3

AISC	American Institute of Steel Construction One E. Wacker Drive, Suite 3100 Chicago, IL 60601
Standard Reference Number	Title
1. ASD 360-05	Specifications for Structural Steel Buildings; Allowable Stress Design And Plastic Design, with Commentary, June, 1989

SECTION 18. Comm 20.24, Table 20.24-4 is repealed.

SECTION 19. Comm 20.24, Table 20.24-5 is renumbered Comm 20.24, Table 20.24-4.

SECTION 20. Comm 20.24, Table 20.24-5 is created to read:

Table 20.24-5

ASCE	American Society of Civil Engineers 1801 Alexander Bell Drive Reston, VA 20191
Standard Reference Number	Title
SEI/ASCE 32-01	Design and Construction of Frost-Protected Shallow Foundations

SECTION 21. Comm 20.24, Table 20.24-6 is amended to read:

Table 20.24-6

ASHRAE	American Society of Heating, Refrigerating, and Air-conditioning Engineers, Inc. 1791 Tullie Circle, N.E. Atlanta, GA 30329
Standard Reference Number	Title
1. 2004 <u>2005</u> Fundamentals	ASHRAE Handbook, Fundamentals
2. 1995 <u>2003</u> HVAC Applications	ASHRAE HVAC Applications Handbook
3. 1996 <u>2004</u> HVAC Systems & Equipment	ASHRAE HVAC Systems & Equipment Handbook

SECTION 22. Comm 20.24, Table 20.24-10 is repealed.

SECTION 23. Comm 20.24, Table 20.24-11 and Table 20.24-12 are renumbered Comm 20.24, Table 20.24-12 and Table 20.24-13 and amended to read:

Table 20.24-12

SMACNA	Sheet Metal and Air Conditioning Contractors National Association Vienna, VA 22180 <u>4201 Lafayette Center Drive</u> <u>Chantilly, VA 20151-1209</u>
Standard Reference Number	Title
1. Seventh Edition, 1998	Residential Comfort System Installation Standards Manual
2. Second Edition, 1995, Including Addendum No. 1, November 1997	HVAC Duct Construction Standards—Metal And Flexible
3. 2. Sixth <u>Seventh</u> Edition, 1992 <u>2003</u>	Fibrous Glass Duct Construction Standards

Table 20.24-13

TPI	Truss Plate Institute, Inc. 583 D'Onofrio Drive Madison, WI 53719 <u>218 North Lee Street, Suite 312</u> <u>Alexandria, VA 22314</u>
Standard Reference Number	Title
1. ANSI/TPI 1-1995 <u>2002</u>	National Design Standard for Metal Plate Connected Wood Truss Construction

SECTION 24. Comm 20.24, Table 20.24-9 is renumbered Comm 20.24, Table 20.24-11.

SECTION 25. Comm 20.24 Table 20.24-7 and Table 20.24-8 are renumbered Comm 20.24 Table 20.24-9 and Table 20.24-10 and amended to read:

Table 20.24-9

NAIMA	North American Insulation Manufacturers Association 44 Canal Center Plaza, Suite 310 Alexandria, VA 22314
Standard Reference Number	Title
1. 3 rd Edition, 1998 <u>2002</u>	Fibrous Glass <u>Residential</u> Duct Construction Standards

Table 20.24-10

NFPA	National Fire Protection Association 1 Batterymarch Park Quincy, MA 02269
Standard Reference Number	Title
1. NFPA 13D <u>2002</u>	<u>Standard for the Installation of Sprinkler Systems in One- and Two-Family Dwellings and Manufactured Homes</u>
1. 2. NFPA 54-1999, chapters 1-4 <u>2006</u>	National Fuel Gas Code

SECTION 26. Comm 20.24, Table 20.24-7 and Table 20.24-8 are created to read:

Table 20.24-7

ICC	The International Code Council 500 New Jersey Avenue, NW, 6 th Floor Washington, D.C. 20001
Standard Reference Number	Title
ICC/ANSI 400-2007	Standard on the Design and Construction of Log Structures

Table 20.24-8

ILBA	The International Log Builders' Association PO Box 775 Lumby, BC Canada V0E 2G0
Standard Reference Number	Title
2000, Section A	Log Building Standards for Residential, Handcrafted, Interlocking, Scribe-fit Construction

SECTION 27. Comm 21.02 (1) (c) 2. and 3. and note are repealed.

SECTION 28. Comm 21.02 (1) (c) 1. is renumbered Comm 21.02 (1) (c).

SECTION 29. Comm 21.02 (3) (title) is amended to read:

Comm 21.02 (3) (title) STRUCTURAL ANALYSIS STANDARDS.

SECTION 30. Comm 21.02 (3) (a) to (e) are renumbered Comm 21.02 (3) (b) to (f).

SECTION 31. Comm 21.02 (3) (intro.) is renumbered Comm 21.02 (3) (a) and amended to read:

Comm 21.02 (3) (a) General. ~~Structural~~ Design, construction, installation, practice and structural analysis shall conform to the following nationally recognized standards.

SECTION 32. Comm 21.02 (3) (b) 3., as renumbered, is created to read:

Comm 21.02 (3) (b) 3. Sawn lumber that is not graded in accordance with the standards under subd. 1., shall use the NDS published allowable design stresses for the lumber species

using grade number 3 when used for studs, stringers, rafters or joists and may use grade number 1 when used for beams, posts or timbers.

SECTION 33. Comm 21.02 (3) (e), as renumbered, is amended to read:

Comm 21.02 (3) (e) Masonry. The design and construction of masonry shall conform to the provisions of the ~~Concrete Masonry Handbook for Architects, Engineers, Builders.~~ following standards:

1. ACI 530, Building Code Requirements for Masonry Structures.
2. ACI 530.1, Specification for Masonry Structures.

SECTION 34. Comm 21.02 (3) (g) is created to read:

Comm 21.02 (3) (g) Whole logs. Dwellings constructed of whole logs shall conform to the following standards:

1. ILBA Log Building Standards for Residential, Handcrafted, Interlocking, Scribe-fit Construction.

Note: This standard requires the minimum log diameter to be 8 inches.

2. ICC/ANSI 400, Standard on the Design and Construction of Log Structures.

SECTION 35. Comm 21.03 (title) and Comm 21.03 (1) (b) are amended to read:

Comm 21.03 (title) Exits, ~~doors and hallways.~~

Comm 21.03 (1) (b) At least one of the exits shall discharge to grade and may not go through a garage. This exit may include interior or exterior stairs.

SECTION 36. Comm 21.03 (3) is repealed and recreated to read:

Comm 21.03 (3) EXITS ABOVE THE SECOND FLOOR. (a) Except as provided under pars. (b) and (c), each habitable floor above the second floor shall be provided with at least 2 exits that meet all of the following requirements:

1. The exits shall be stairways or ramps that lead to the second floor or discharge to grade.
2. The exits shall be located such that an exit is accessible to the second floor if another exit is blocked.

(b) A second stairway or ramp exit is not required for habitable areas on a third floor that meet all of the following requirements:

1. The habitable area consists of a single room.

Note: Non-habitable areas, such as closets and bathrooms may be partitioned off.

2. The room is not used for sleeping.
3. The habitable area has a floor area of 400 square feet or less.
4. There is at least one egress window meeting the requirements of sub. (6) in the habitable area.

(c) A second stairway or ramp exit is not required for habitable areas on a third floor that meet all of the following requirements:

1. The dwelling is fully sprinklered in accordance with NFPA 13R or NFPA 13D.
2. If a required exit includes an attached garage, the garage shall be sprinklered.

SECTION 37. Comm 21.03 (6) (e) 5. is amended to read:

Comm 21.03 (6) (e) 5. a. Ladders or other steps used to comply with subd. 4. may infringe on the required area of the areaway by a maximum of 6 inches.

b. Ladder rungs shall have a minimum inside width of at least 12 inches and shall project at least 3 inches from the wall behind the ladder.

c. Ladder rungs shall be able to support a concentrated load of 200 pounds.

d. Ladder rungs shall have a maximum rise of 12 inches between rungs and shall extend to within 12 inches of exterior grade.

SECTION 38. Comm 21.03 (7) is repealed and recreated to read:

Comm 21.03 (7) DOORS USED FOR EXITING. (a) Doors used for exiting from a dwelling shall meet the following dimensions:

1. At least one exit door shall be a swing-type door at least 80 inches high by 36 inches wide.
2. Except as allowed under subds. 3. and 4., other required exit doors shall be at least 76 inches high by 32 inches wide.

3. Where double doors are used as a required exit, each door leaf shall provide a clear opening at least 30 inches wide and be at least 76 inches high.

4. Where sliding doors are used as a required exit, the clear opening shall be at least 30 inches wide and be at least 76 inches high.

(b) All exit doors shall be openable from the interior without the use of a key.

SECTION 39. Comm 21.03 (8) and (9) are repealed.

SECTION 40. Comm 21.03 (10) to (12) are renumbered Comm 21.03 (8) to (10).

SECTION 41. Comm 21.035 is created to read:

Comm 21.035 Interior circulation. (1) DOORS AND OPENINGS. All doors and openings to the following areas shall be at least 80 inches high and provide either a net clear opening width of 30 inches or be a 32-inch door:

(a) Except as provided under pars. (b) and (c), all entrances into common use areas.

(b) At least 50% of the bedrooms.

(c) 1. At least one full bathroom, including doors or openings to a sink, toilet and tub or shower. If this bathroom is accessible only through a bedroom, the bedroom door shall meet the minimum width requirements of this section.

2. If one or more full bathrooms are provided on the first floor, the bathroom meeting the requirements under this section shall be on the first floor.

Note: This section does not require a full bathroom on the first floor.

(2) HALLWAYS. (a) Except as allowed under par. (b), the clear width of hallways shall be at least 36 inches.

(b) The following are allowed to infringe on the required clear width of a hallway:

1. Door hardware and finish trim.

2. Handrails may infringe into the minimum width of a hallway up to 4½ inches on each side.

3. Heating registers may infringe into the minimum width of a hallway up to 4½ inches and no part of the register may be more than 38 inches above the floor.

4. Ducts, pipes, light fixtures, structural features, and corner treatments that are within 84 inches of the floor may infringe into the minimum width of a hallway by a maximum of 4½ inches on each side.

5. Unlimited infringements are allowed in a hallway more than 84 inches above the floor.

(3) KITCHENS. (a) There shall be at least 30 inches of clearance between a wall, a permanently-installed kitchen island, permanently-installed kitchen cabinets and the following kitchen appliances, if provided:

1. A range, cook top or oven.
2. A sink, refrigerator or freezer.

(b) Measurements shall be taken from the face of the wall, island, cabinet or appliance, ignoring knobs and handles.

Note: See ICC/ANSI A117.1 chapter 10 for more guidelines relating to doors and accessible routes. Under that standard, doors must be at least 80-inches in height and provide a minimum net clear opening of 31-3/4-inches in width in order to provide accessibility for people with disabilities.

SECTION 42. Comm 21.04 (1) is repealed and recreated to read:

Comm 21.04 (1) SCOPE. (a) *General.* Except as provided under par. (b), the following stairways shall conform to the requirements of this section.

1. Every interior and exterior stairway attached to, or supported by any part of the structure covered under this code.
2. Tub access steps, unless they are an integral part of an approved plumbing product.

(b) *Exceptions.* The following stairways are not required to comply with the requirements of this section:

1. Stairways leading to non-habitable attics or crawl spaces.
2. Non-required stairways connecting the basement directly to the exterior of the structure without communicating with any other part of the structure.

SECTION 43. Comm 21.04 (2) (c) 2. and Comm 21.04 (2) (c) 3. b. are amended to read:

Comm 21.04 (2) (c) 2. ‘Spiral staircase treads.’ Spiral staircase treads shall have a minimum tread depth of 7 inches from nosing to nosing measured at a point 12 inches from the ~~narrow end of the tread~~ outer edge of the center column.

Comm 21.04 (2) (c) 3. b. The depth of the immediately adjoining winder treads shall be equal at a point 12 inches from the narrow end of the tread or inside face of spindles or balusters.

SECTION 44. Comm 21.04 (2) (c) 3. c. and Comm 21.04 (2) (c) 4. c. are created to read:

Comm 21.04 (2) (c) 3. c. Winder treads may not be used on a straight stairway.

Comm 21.04 (2) (c) 4. c. Winder treads may not be used on a straight stairway.

SECTION 45. Comm 21.04 (2) (e) 1. is amended to read:

Comm 21.04 (2) (e) 1. Within a stairway flight, the greatest tread depths depth may not exceed the smallest tread depth by more than and riser heights may vary by a maximum of 3/16 3/8 inch and the greatest riser height may not exceed the smallest riser height by more than 3/8 inch.

SECTION 46. Comm 21.04 (2) (g) and Comm 21.04 (3) (a) 2. note are created to read:

Comm 21.04 (2) (g) *Walking surface.* The walking surface of stair treads and landings shall be a planar surface that is free of lips or protrusions that could present a tripping hazard.

Comm 21.04 (3) (a) 2. note:

Note: A handrail provided at 30 to 38 inches above the tread nosing meets the height requirement for a guardrail on a stairway.

SECTION 47. Comm 21.04 (3) (a) 3. c. is created to read:

Comm 21.04 (3) (a) 3. c. Rope, cable or similar materials used in handrail or guardrail infill shall be strung with maximum openings of 3½ inches with vertical supports a maximum of 4 feet apart.

Note: In some cases, the vertical supports could be simple cable stays that offer vertical support to the rope or cable span. Structural posts must be supplied to provide the rail with the minimum 200 pound load resistance, as well as to resist the tensile loads exerted by the tightened rope or cable.

SECTION 48. Comm 21.04 (3) (a) 4. is renumbered Comm 21.04 (3) (a) 4. a.

SECTION 49. Comm 21.04 (3) (a) 4. b. and c. are created to read:

Comm 21.04 (3) (a) 4. b. Handrail or guardrail infill components, balusters and panel fillers shall withstand a horizontally applied perpendicular load of 50 pounds on any one-foot-square area.

c. Glazing used in handrail or guardrail assemblies shall be safety glazing.

SECTION 50. Comm 21.04 (3) (c) 1. is amended to read:

Comm 21.04 (3) (c) 1. ‘Application.’ a. All openings between floors, and open sides of landings, platforms, balconies or porches that are more than 24 inches above grade or a floor shall be protected with guardrails.

b. The requirements under subpar. a. apply where insect screens are the only means of enclosure or protection for a surface that is more than 24 inches above grade or a floor.

c. For exterior applications, the 24 inch vertical measurement shall be taken from the lowest point within 3 feet horizontally from the edge of the deck, landing, porch or similar structure.

SECTION 51. Comm 21.045 (1) to (4) are renumbered Comm 21.045 (2) to (5).

SECTION 52. Comm 21.045 (intro.) is renumbered Comm 21.045 (1) and amended to read:

Comm 21.045 (1) GENERAL. Every exterior or interior ramp which leads to or from a ~~required~~ an exit shall comply with the requirements of this section.

SECTION 53. Comm 21.045 (1) Note is created to read:

Comm 21.045 (1) Note: See ICC/ANSI A117.1 chapter 5 for more guidelines relating to the design and construction of an accessible ramp. Under that standard, ramps along an accessible route for people with disabilities should have a slope of not more than 1-foot of rise in 12-feet of run and should have handrails on both sides of the ramp.

SECTION 54. Comm 21.05 (title) is amended to read:

Comm 21.05 (title) ~~Light~~ Natural light and natural ventilation.

SECTION 55. Comm 21.05 (3) and (4) are repealed.

SECTION 56. Comm 21.05 (5) is renumbered Comm 21.05 (3).

SECTION 57. Comm 21.05 (3) (intro.), as renumbered, is amended to read:

Comm 21.05 (3) (intro.) SAFETY GLASS. Except as provided in par. (e), glazing shall consist of safety glass meeting the requirements of ~~ANSI Z97.1~~ CPSC 16 CFR, Part 1201 when installed in any of the following locations:

SECTION 58. Comm 21.05 (3) (a) and Comm 21.05 (3) (b), as renumbered, are repealed and recreated to read:

Comm 21.05 (3) (a) In any sidelight or glazing adjacent to a door that meets all of the following:

1. The nearest point of the glazing is within 2 feet of the door.
2. The nearest point of the glazing is within 5 feet of the floor.
3. The plane of the glazing is within 30 degrees of the plane of the door when the door is in the closed position.

Comm 21.05 (3) (b) In any wall where the glazing is within 5 feet vertically of the lowest drain inlet and within 3 feet horizontally of the nearest part of the inner rim of a bathtub, hot tub, shower, spa or whirlpool appliance.

SECTION 59. Comm 21.05 (3) note 2 is created to read.

Comm 21.05 (3) Note 2: Glass blocks are considered to be masonry products and are regulated under the ACI 530 standard adopted under s. Comm 20.24. They are not required to be safety glazing.

SECTION 60. Comm 21.08 (1) (intro.) and Table 21.08 are amended to read:

Comm 21.08 (1) (intro.) FIRE SEPARATION. Dwelling units shall be separated from garage spaces, accessory buildings, property lines and other dwelling units in accordance with Table 21.08 and the following requirements:

Table 21.08 (partial table)
[Note to Revisor: Add this row to the end of current Table 21.08]

Between Single Family Dwelling And:	Distance Between Objects ¹	Fire Rated Construction ^{2,5}
<u>Zero Lot Line</u>	<u>None</u>	<u>Follow sub. (2) (c) requirements</u>

SECTION 61. Comm 21.08 (1) (a) 4. is repealed.

SECTION 62. Comm 21.08 (1) (c) is renumbered Comm 21.08 (1) (c) 1.

SECTION 63. Comm 21.08 (1) (c) 2. is created to read:

Comm 21.08 (1) (c) 2. Only glazing allowed by the door's listing may be installed in any door required under this section.

SECTION 64. Comm 21.08 (1) (d) 1. is repealed and recreated to read:

Comm 21.08 (1) (d) 1. Access openings in fire separation walls or ceilings shall be protected in one of the following ways:

- a. The opening is protected with a material that has a finish rating of at least 20 minutes.
- b. The opening is protected in the same way as the wall or ceiling where the opening is located.

SECTION 65. Comm 21.08 (2) (a) is repealed and recreated to read:

Comm 21.08 (2) (a) General. In 2-family dwellings, dwelling units shall be separated from each other and from shared tenant spaces including attics, basements, garages, vestibules and corridors.

SECTION 66. Comm 21.08 (2) (e) is repealed.

SECTION 67. Comm 21.08 (2) (b), (c) and (d) are renumbered Comm 21.08 (2) (c), (d) and (e).

SECTION 68. Comm 21.08 (2) (b) is created to read:

Comm 21.08 (2) (b) Attic separation. Dwelling units with attic space that extends over both units shall be separated in accordance with one of the following:

1. ‘Complete separation.’ The units shall be provided with wall construction under par. (d) that extends all the way to the underside of the roof deck.

2. ‘Vertical and horizontal separation.’ a. The units shall be provided with wall construction under par. (d) that extends to the dwelling unit ceiling and ceiling construction under par (e).

b. Dwelling units using this method of separation shall provide attic draft stopping under par. (f) that extends all the way to the underside of the roof deck above and in line with the separation wall.

SECTION 69. Comm 21.08 (2) (d), as renumbered, is amended to read:

Comm 21.08 (2) (d) Walls. Walls in the dwelling unit separation shall be protected by not less than one layer of ~~½-inch~~ 5/8-inch Type X gypsum wallboard or 2 layers of ½-inch gypsum wallboard or equivalent on each side of the wall with joints in compliance with sub. (1) (a) 2.

SECTION 70. Comm 21.08 (2) (f) is created to read:

Comm 21.08 (2) (f) Draft stopping for concealed roof spaces and attics. 1. Attic areas, mansards, overhangs and other concealed roof spaces shall be draft stopped above and in line with the separation wall.

2. Acceptable draft stopping materials include:

a. 3/8-inch wood structural panel.

b. ½-inch gypsum board.

SECTION 71. Comm 21.09 (1) (b), Comm 21.09 (2) and Comm 21.09 (3) are amended to read:

Comm 21.09 (1) (b) On floor levels that contain one or more sleeping areas, an alarm shall be installed outside of the sleeping rooms, ~~in the vicinity of each sleeping area within 21 feet of the centerline of the door opening to any sleeping room and in an exit path from any sleeping room.~~

(2) Smoke (a) ~~Except for dwellings with no electrical service, smoke~~ detectors required by this section shall be continuously powered by the house electrical service, and shall be interconnected so that activation of one detector will cause activation of all detectors.

(b) Dwellings with no electrical service shall be provided with battery-powered smoke detectors in the locations under sub. (1). Interconnection and battery-backup are not required in these dwellings.

(3) For family living units with one or more communicating split levels or open adjacent levels with less than ~~one full story~~ 5 feet of separation between levels, one smoke detector on the upper level shall suffice for an adjacent lower level, including basements. Where there is an intervening door between one level and the adjacent lower level, smoke detectors shall be installed on each level.

SECTION 72. Comm 21.09 (6) is created to read:

Comm 21.09 (6) In basements where two required exits are separated by a continuous wall, a smoke detector shall be placed on each side of the wall within 21 feet of each exit.

SECTION 73. Comm 21.095 is created to read:

Comm 21.095 Automatic fire sprinklers. (1) Except as allowed under sub. (2), where automatic fire sprinklers using a dedicated water supply system are installed, the design, installation, testing and maintenance shall follow the requirements of NFPA 13D.

(2) Limited area dwelling systems are allowed.

Note: See s. Comm 82.40 (3) (e) of the Wisconsin Uniform Plumbing Code for requirements for multi-purpose piping systems. These systems attach fire sprinkler heads to the dwelling's potable water piping system.

Note: Chapter 145, Stats., requires automatic fire sprinkler systems, on dedicated water supply systems, to be installed by a licensed sprinkler fitter.

SECTION 74. Comm 21.10 (1) and Comm 21.10 (2) (a) are amended to read:

Comm 21.10 Protection against decay and termites. (1) Wood used in any of the ~~locations specified~~ applications under this section shall meet all of the following requirements:

(a) The wood shall be labeled and pressure treated with preservative in accordance with an AWWA standard or shall be a naturally durable and decay-resistant ~~species~~ or shall be engineered to be decay resistant.

(b) The wood shall be pressure treated with preservative or shall be naturally termite-resistant unless additional steps are taken to make the wood termite-resistant.

Comm 21.10 (2) (a) Resting directly upon or embedded in earth.

SECTION 75. Comm 21.10 (2) (b) is repealed and recreated to read:

Comm 21.10 (2) (b) Floor joists or sleepers that meet all of the following conditions:

1. The joists or sleepers are protected from the weather.
2. The joists or sleepers are within 18 inches above a lower floor surface, deck or soil.
3. There is no vapor retarder that meets the requirements under s. Comm 21.05 (4) (b) between the joists or sleepers and the soil below.

Note: This situation could occur with a floor over a crawl space or when a floor is added over a patio deck or a garage slab.

SECTION 76. Comm 21.10 (2) (g) is repealed.

SECTION 77. Comm 21.10 (2) (c) to (f) are renumbered Comm 21.10 (2) (d) to (g).

SECTION 78. Comm 21.10 (2) (c) is created to read:

Comm 21.10 (2) (c) Floor joists exterior to the dwelling that are within 18 inches above exterior grade, unless protected with a moisture barrier.

Note: Acceptable moisture barriers for this application include 3/4-inch exterior preservative-treated plywood, or ice dam protection material listed as meeting the requirements of ASTM D 1970 or vapor retarder material, provided they are protected from physical and UV light damage.

SECTION 79. Comm 21.10 (2) (e), Comm 21.10 (2) (f) 1. and Comm 21.10 (2) (g), as renumbered, are amended to read:

Comm 21.10 (2) (e) Sills and rim joists that rest on concrete or masonry and are also below grade or within 8 inches above final exterior grade.

Comm 21.10 (2) (f) 1. Siding and sheathing in contact with concrete, masonry or earth and within 6 inches of earth above final exterior grade.

Comm 21.10 (2) (g) Ends of wood structural members built into and their shims resting on or supported in masonry or concrete walls and having clearances of less than 1/2 inch on the top, sides and ends.

SECTION 80. Comm 21.10 (2) (h) is repealed and recreated to read:

Comm 21.10 (2) (h) Bottom plates or sole plates of walls that rest on concrete or masonry and that are below exterior grade or less than 8 inches above final exterior grade.

SECTION 81. Comm 21.10 (2) (i) is amended to read:

Comm 21.10 (2) (i) Columns in direct contact with concrete or masonry unless supported by a structural pedestal or plinth block at least ~~3 inches~~ one inch above the floor.

SECTION 82. Comm 21.10 (2) (k) is created to read:

Comm 21.10 (2) (k) Permanent wood foundations.

SECTION 83. Comm 21.10 (4) (b) is repealed.

SECTION 84. Comm 21.10 (4) (a) is renumbered Comm 21.10 (4).

SECTION 85. Comm 21.10 (5) and Comm 21.11 Note are created to read:

Comm 21.10 (5) FASTENERS. (a) Fasteners for pressure-preservative treated wood and fire-retardant-treated wood shall meet one of the following requirements:

1. The fastener is a steel bolt with a diameter of 0.5 inch or greater.
2. The fastener is made of stainless steel.
3. The fastener is made of hot-dipped, zinc-galvanized steel with the coating weight and thickness labeled as complying with ASTM A 153.
4. The fastener is made of steel with a mechanically-deposited zinc coating labeled as complying with ASTM B 695, Class 55 or greater.
5. The fastener has coating types and weights in accordance with the fastener manufacturer's recommendations. In the absence of the manufacturer's recommendations subd. 1., 2., 3., or 4. shall apply.

Note: "Zinc plated," "zinc coated," "chrome plated," etc. fasteners do not necessarily comply with either of these standards.

(b) When a fastener is used with a hanger or other metal fixture, the fastener shall be of the same material as the hanger or metal fixture.

Note: When separate pieces are in close contact, zinc corrodes rapidly in the presence of plain steel. Zinc corrodes much more rapidly in the presence of stainless steel.

(c) For the purposes of this section, a fastener includes nails, screws and bolts, along with nuts and washers.

Comm 21.11 Note: See s. Comm 22.04 (2) for requirements for protecting foam plastic on the exterior of a dwelling.

SECTION 86. Comm 21.15 (1) and (2) are renumbered Comm 21.15 (2) and (3), and Comm 21.15 (intro.) is renumbered Comm 21.15 (1).

SECTION 87. Comm 21.15 (1), as renumbered, is amended to read:

Comm 21.15 (1) *General.* (a) The dwelling and attached structures, such as decks and garages, shall be supported on a structural system designed to transmit and safely distribute the loads to the soil.

(b) The loads for determining the footing size shall include the weight of the live load, roof, walls, floors, pier or column, plus the weight of the structural system and the soil over the footing.

(c) Footings shall be sized to not exceed the allowable material stresses.

(d) The bearing area shall be at least equal to the area required to transfer the loads to the supporting soil without exceeding the bearing ~~values~~ capacity of the soil.

(e) Structures supported on floating slabs or similar shallow foundations may not be physically attached to structures that are supported by footings that extend below the frost line unless an isolation joint is used between the structures. This isolation shall extend for the full height of the structure.

SECTION 88. Comm 21.15 (2) (a) Note, as renumbered, is amended to read:

Comm 21.15 (2) (a) Note: Unstable soil includes soils that are unable to support themselves at a 90 degree angle for the full depth of the footing.

SECTION 89. Comm 21.15 (2) (b), as renumbered, is amended to read:

Comm 21.15 (2) (b) *Column or pier footing.* 1. The minimum width and length of column or pier footings shall measure at least 2 feet by 2 feet.

2. The minimum depth of column or pier footings shall measure at least 12 inches nominal. ~~The column shall be so placed as to provide equal projections on each side of the column.~~

SECTION 90. Comm 21.15 (2) (e), as renumbered, is amended to read:

Comm 21.15 (2) (e) *Floating slabs.* Any dwelling supported on a floating slab on grade shall be designed through structural analysis. ~~Structures supported on floating slabs may not be physically attached to structures that are supported by footings that extend below the frost line unless an isolation joint is used between the structures.~~

SECTION 91. Comm 21.16 is repealed and recreated to read:

Comm 21.16 Frost protection. (1) GENERAL. (a) Except as allowed under sub. (2), footings and foundations, including those for ramps and stoops, shall be placed below the frost penetration level or at least 48 inches below adjacent grade, whichever is deeper.

(b) Footings may not be placed on frozen material.

(2) EXCEPTIONS. (a) Frost protected shallow foundations shall be designed in accordance with ASCE-32 as adopted in Table Comm 20.24-5.

(b) Portions of footings or foundations located directly under window areaways do not require frost protection provided the rest of the foundation is protected in accordance with this section.

(c) Footings and foundations may bear directly on bedrock less than 48 inches below adjacent grade provided all of the following conditions are met.

1. The rock shall be cleaned of all earth prior to placement.
2. All clay in crevices of the rock shall be removed to the level of frost penetration or to 1.5 times the width of the rock crevice, whichever is less.
3. Provisions shall be taken to prevent water from collecting anywhere along the foundation.

SECTION 92. Comm 21.17 (1) (a) 2. and Comm 21.17 (1) (b) 2. are amended to read:

Comm 21.17 (1) (a) 2. For the purposes of this section, a complete drain tile or pipe system includes all of the following:

a. The drain tile or pipe installed inside and outside the foundation ~~at the footing level.~~ except as allowed under s. Comm 21.17 (3) (d) 1. b.

b. Bleeders connecting the inside tile or pipe to the outside tile or pipe.

c. The sump pit or crock.

d. The discharge piping.

e. ~~and a~~ A pump or other means of discharging water to ~~natural~~ grade.

Comm 21.17 (1) (b) 2. For the purposes of this section, a partial drain tile or pipe system includes a means of discharging water from the tile or pipe and may include any of the other elements under par. (a) 2.

Note: Means of discharging water include a sump pit, a crock or natural means of drainage to daylight.

SECTION 93. Comm 21.17 (3) (d) 1. to 6. are renumbered Comm 21.17 (3) (d) 2. to 7.

SECTION 94. Comm 21.17 (3) (d) 1. is created to read:

Comm 21.17 (3) (d) 1. a. Except as allowed under subd. 1. b., the top of the tile or pipe shall be at or below the top of the footing.

b. Where the top of the footing is more than 4 inches below the bottom of the floor slab, tile or pipe is required on the interior of the foundation only and it shall be placed directly under the floor.

Note: This situation will commonly occur with a walk-out basement.

SECTION 95. Comm 21.17 (3) (d) 6., as renumbered, is amended to read:

Comm 21.17 (3) (d) 6. a. Bleeder tiles or pipes shall be provided at no more than 8-foot intervals to connect the exterior drain tile or pipe to the interior drain tile or pipe.

b. Bleeder tiles or pipes shall have a minimum interior diameter of 3 inches.

c. Direct connection of the bleeders is not required if the intersection of the bleeder with the tile or pipe is covered with a membrane or fabric that prevents soil and fines from entering the system.

SECTION 96. Comm 21.18 (1) (d) 1. Note is created to read:

Comm 21.18 (1) (d) 1. Note: Per s. Comm 21.22 (1), sill plates are not required on foundation walls of poured concrete or on masonry walls with mortar- or grout-filled cores or on masonry walls with a solid block top course.

SECTION 97. Comm 21.18 (1) (d) 2. b. is amended to read:

Comm 21.18 (1) (d) 2. b. ~~Solid blocking~~ Blocking and bridging shall be the same depth as the joist.

SECTION 98. Comm 21.18 (2) (a) (title), Comm 21.18 (2) (b) (title) and Comm 21.18 (2) Note are created to read:

Comm 21.18 (2) (a) (title) *General structural requirements.*

Comm 21.18 (2) (b) (title) *Equalized loading.*

Comm 21.18 (2) Note: See s. Comm 21.15 (1) (c) for trench footing requirements.

SECTION 99. Comm 21.18 (3) (a) is repealed and recreated to read:

Comm 21.18 (3) (a) *Dampproofing.* 1. Except as allowed under subd. 3., masonry block foundation walls shall be coated with a layer of minimum 3/8-inch thick type M or S portland cement mortar parging on the exterior of the wall from footing to finished grade.

2. Masonry foundation walls shall be damp-proofed by applying to the exterior surface of the portland cement parging from footing to finished grade, a continuous coating of one of the following:

- a. A bituminous coating applied in accordance with the manufacturer's instructions.
- b. Acrylic-modified cement applied at a minimum rate of 3 pounds per square yard.
- c. A layer of minimum 1/8-inch thick structural surface bonding material labeled as complying with ASTM C887.

Note: The ASTM C887 standard is entitled, "Standard Specification for Packaged, Dry, Combined Materials for Surface Bonding Mortar."

d. A waterproofing treatment applied in accordance with the manufacturer's instructions.

3. a. Parging of masonry block foundation walls is not required where a dampproofing material is sufficiently flexible to be listed or designed for direct application to masonry block.

b. Parging of masonry block foundation walls is not required where a layer of minimum 1/4-inch thick structural surface bonding material labeled as complying with ASTM C887 is used for dampproofing.

SECTION 100. Comm 21.18, Table 21.18-C footnote a, Table 21.18-D footnote a, Table 21.18-E footnote a, and Table 21.18-F footnote a are amended to read:

Comm 21.18, Table 21.18-C footnote a, Table 21.18-D footnote a, Table 21.18-E footnote a, and Table 21.18-F footnote a: For design lateral soil loads, see s. Comm 21.18 (1) ~~(d)~~ (e). Soil classes are in accordance with the Unified Soil Classification System and design lateral soil loads are for moist soil conditions without hydrostatic pressure.

SECTION 101. Comm 21.18 (4) and Comm 21.22 (1) are repealed and recreated to read:

Comm 21.18 (4) WOOD FOUNDATIONS. Wood foundations shall be designed and constructed in accordance with the standard adopted in Table 20.24-2.

Note: The department will accept Permanent Wood Foundations Design and Construction Guide published by the Southern Forest Products Association through the Southern Pine Council, as complying with this standard. The Design and Construction Guide requires a 3.5 inch thick floor slab if a poured concrete floor slab is used.

Comm 21.22 (1) FLOOR JOISTS. (a) *General.* 1. Floor joists shall comply with the structural requirements and live load determination under s. Comm 21.02.

2. Where the joists of a floor system are parallel to, and located between bearing walls above and below, the joists shall be doubled.

(b) *Floor joists on concrete walls.* Where a sill plate is provided for floor joists on poured concrete, the sill plates shall be fastened to the foundation.

Note: Section Comm 21.18 (1) (d) requires the floor joists to also be fastened to the sill plate.

(c) *Floor joists on masonry walls with a solid top course.* Where a sill plate is provided for floor joists on solid block top course masonry, the sill plate shall be fastened to the foundation.

(d) *Floor joists on masonry walls with open top course.* 1. Where the masonry wall has an open top course, a sill plate at least as wide as the foundation wall shall be fastened to the foundation.

2. Where anchor bolts are used on masonry walls with an open top course, the minimum width of an individual piece making up the sill plate shall be at least 5.5 inches.

Note: A sill plate can be made of multiple pieces to achieve the full width.

SECTION 102. Comm 21.22 (1m) is repealed.

SECTION 103. Comm 21.22 (3) (intro.), (a) and (b) are renumbered Comm 21.22 (3) (a), (b) and (c).

SECTION 104. Comm 21.22 (3) (d) is created to read:

Comm 21.22 (3) (d) Lateral restraint for all wood beams shall be provided at all columns using a saddle or other approved connection where the beam meets one of the following conditions:

1. The beam is not restrained at both ends.
2. The beam is more than 11.25 inches deep using actual measurement.

Note: A saddle supports the beam on the bottom and allows for the through-connection of fasteners into the side of the beam

SECTION 105. Comm 21.22 (8) (b) and Table 21.22-C are repealed.

SECTION 106. Comm 21.24 (2) is amended to read:

Comm 21.24 (2) DURING CONSTRUCTION. During construction, wall cavity insulation may not be installed until a water-resistant ~~exterior~~ covering is in place over the wall cavity and windows, doors and a roof with at least underlayment are installed.

SECTION 107. Comm 21.24 (2) Note is amended to read:

Comm 21.24 (2) Note: An example of acceptable water-resistant covering for a wall is foam sheathing with permanently taped joints ~~and the permanent doors and windows installed.~~

SECTION 108. Comm 21.24 (3) (c) is renumbered Comm 21.24 (3) (d).

SECTION 109. Comm 21.24 (3) (c), Comm 21.24 (3) Note, and Comm 21.24 (4) are created to read:

Comm 21.24 (3) (c) 1. Any joints between 2 pieces of flashing that form a vertical joint shall be lapped a minimum of 6 inches and sealed.

2. Any joints between 2 pieces of flashing that form a horizontal joint shall be lapped a minimum of 2 inches and sealed unless otherwise specified by the flashing manufacturer.

3. Sealants used for flashing shall be exterior grade and shall be compatible with the materials being sealed.

Comm 21.24 (3) Note: See s. Comm 21.26 (5) for additional flashing requirements with masonry cavity walls and s. Comm 21.28 (7) for additional flashing requirements with roofing.

Comm 21.24 (4) WATER-RESISTIVE BARRIER REQUIREMENTS. (a) *General.* 1. Exterior walls of wood or metal frame construction shall be provided with a water-resistive barrier from the highest point to the bottom of the permanent weather-resistant covering.

Note: Acceptable water-resistive barrier materials include polymeric-based house wraps and spray-applied water-resistive barriers installed per the manufacturer's instructions, # 15 or greater asphalt-saturated felts that comply with ASTM D 226 for type I felt, and extruded foam sheathing with permanently taped joints. Duct tape or similar will not result in a permanently taped joint.

2. Structural products with an integral water-resistive barrier may be approved by the department as a complete assembly.

(b) *Material compatibility.* The water-resistive barrier material shall be compatible with the other materials in the wall with which it will come into contact.

Note: Spray-applied water-resistive barriers may not be compatible with foam plastic insulation.

(c) *Performance requirements.* 1. Polymer-based house wraps shall meet all of the following requirements:

a. A water vapor permeability rating of 5 perms or higher when tested in accordance with ASTM E96.

b. An acceptable water-resistance rating determined in accordance with ASTM D779, AATCC 127 or CCMC 07102.

Note: Asphalt-saturated felt or "tar paper" is not a polymeric-based house wrap.

Note: For more information on the water-resistance tests and their results, see the International Code Council Evaluation Services Acceptance Criteria AC 38.

2. Spray-applied water-resistive barriers shall be approved under the International Code Council Evaluation Services.

Note: For approval criteria, see ICC – ES acceptance criteria AC 212 or successor document.

(d) *Application.* 1. Horizontal seams in sheet or strip material shall be overlapped such that the upper layer extends over the lower layer at least 2 inches.

2. Vertical seams in sheet or strip materials shall be overlapped at least 6 inches.

3. Any rips, tears or voids shall be patched in accordance with subds. 1. and 2.

(e) *Penetrations.* 1. Penetrations caused by fasteners of the water-resistive barrier or the weather-resistant exterior covering do not require sealing.

2. Penetrations of 5 square inches or less with an annular space of no more than ½ inch shall be sealed with caulk or similar material.

3. Penetrations of greater than 5 square inches shall be flashed in accordance with sub. (3).

SECTION 110. Comm 21.25 (1) (title) is amended to read:

Comm 21.25 (1) (title) **STUD CONFIGURATION ~~AND BRACING~~.**

SECTION 111. Comm 21.25 (1) (b) is repealed.

SECTION 112. Comm 21.25 (1) (a) is renumbered Comm 21.25 (1).

SECTION 113. Comm 21.25 Table 21.25-A is repealed and recreated to read:

**TABLE 21.25-A
SIZE, HEIGHT AND SPACING OF WOOD STUDS^a**

STUD SIZE (inches)	BEARING WALLS					NONBEARING WALLS	
	Laterally unsupported stud height ^a (feet)	Maximum spacing when supporting roof and ceiling only (inches)	Maximum spacing when supporting one floor, roof and ceiling (inches)	Maximum spacing when supporting two floors, roof and ceiling (inches)	Maximum spacing when supporting one floor only (inches)	Laterally unsupported stud height ^a (feet)	Maximum spacing (inches)
2 x 3 ^b	-	-	-	-	-	10	16
2 x 4	10	24	16	-	24	14	24
3 x 4	10	24	24	16	24	14	24
2 x 5	10	24	24	-	24	16	24
2 x 6	10	24	24	16	24	20	24

a. Listed heights are distances between points of lateral support placed perpendicular to the plane of the wall. Increases in unsupported height are permitted where justified by analysis.

b. May not be used in exterior walls.

SECTION 114. Comm 21.25 (6) (a) 4. is renumbered Comm 21.25 (6) (a) 5.

SECTION 115. Comm 21.25 (6) (a) 4., and Comm 21.25 (7), (8) and (9) are created to read:

Comm 21.25 (6) (a) 4. All columns shall be positively attached to the beams they support using clips, straps or saddles.

Comm 21.25 (7) FOUNDATION CRIPPLE WALLS. (a) Foundation cripple walls shall be framed with studs at least as large as the studs above.

(b) When more than 4 feet in height, cripple walls shall be framed with studs needed for an additional floor level.

(c) Cripple walls with a stud height of less than 14 inches shall be sheathed on at least one side for its entire length with a wood structural panel that is fastened to both the top and bottom plates or the cripple walls shall be constructed of solid blocking.

(d) Cripple walls with a stud height of 14 inches or greater shall be braced in accordance with sub. (8) or (9).

(e) Cripple walls shall be fully supported by a continuous foundation.

Comm 21.25 (8) WALL BRACING. (a) *General.* Dwellings using wood-framed walls shall be braced in accordance with this section. Where a building, or a portion thereof, does not comply with one or more of the bracing requirements in this section, those portions shall be designed and constructed in accordance with accepted engineering practice.

Note: Acceptable engineering wall bracing practices include the provisions under s. R602.10 of the International Residential Code–2009.

(b) *Bracing Materials and Methods.* Braced wall lines, both interior and exterior shall be braced using one of the following materials and methods:

1. a. Nominal 1-inch-by-4-inch continuous diagonal braces let in to the top and bottom plates.

b. The let-in bracing shall be placed at an angle not more than 60 degrees or less than 45 degrees from the horizontal.

2. a. Preformed metal continuous diagonal T-bracing not less than 22 gage thick and 1 ¾ inch wide let in to the top and bottom plates and the intervening studs installed in accordance with the manufacturer's specifications.

b. The let-in bracing shall be placed at an angle not more than 60 degrees or less than 45 degrees from the horizontal.

Note: 22 gage steel is 0.03 inches thick.

3. Wood boards of 5/8-inch net minimum thickness applied diagonally on studs spaced a maximum of 24 inches fastened to studs in accordance with the fastener table in the appendix.

4. Wood structural panel sheathing with all edges fastened to framing or blocking in accordance with the fastener table in the appendix and not less than 3/8 inch thick for 16-inch stud spacing and not less than 7/16 inch thick for 24-inch stud spacing.

5. Minimum ½-inch thick structural fiberboard sheathing applied vertically or horizontally on studs spaced a maximum of 16 inches on center. Structural fiberboard sheathing shall be installed in accordance with the fastener table in the appendix.

6. Gypsum board with minimum ½-inch thickness placed on studs spaced a maximum of 24 inches on center and fastened at panel edges including top and bottom plates at 7 inches on center with the size nails specified in the fastener table in the appendix.

7. Alternative methods under par. (9), including Alternate Braced Wall Panels, par. (9) (b), and Continuously Sheathed Braced Wall Lines using Wood Structural Panels, par. (9) (c)..

8. Other approved wind bracing materials and methods.

Note: See Appendix for acceptable nailing schedule.

(c) *Minimum length of braced panels.* 1. ‘General.’ Except as provided under subd. 2., the minimum lengths shall be as follows:

a. For methods under par. (b) 3., 4. and 5., each braced wall panel shall be at least 48 inches in length, covering a minimum of three stud spaces where studs are spaced 16 inches on center and covering a minimum of two stud spaces where studs are spaced 24 inches on center.

b. For the method under par. (b) 6., each braced wall panel and shall be at least 96 inches in length where applied to one face of a braced wall panel and at least 48 inches in length where applied to both faces.

c. For methods under par. (b) 3., 4. and 5., for purposes of computing the percentage of panel bracing required in Table 21.25-H, the effective length of the braced wall panel shall be equal to the actual length of the panel.

d. When the method under par. (b) 6. panels are applied to only one face of a braced wall panel, bracing percentages required in Table 21.25-H under other methods permitted column shall be doubled.

2. ‘Exceptions.’ a. Lengths of braced wall panels for continuous wood structural panel sheathing shall be in accordance with sub. (9) (c).

b. Lengths of alternate braced wall panels shall be in accordance with sub. (9) (a) or (b).

c. For methods under par. (b) 3., 4. and 5., panels between 36 inches and 48 inches in length shall be permitted to count towards the required percentage of bracing in Table 21.25-H, and the effective contribution shall comply with Table 21.25-G.

TABLE 21-25-G
EFFECTIVE LENGTHS FOR BRACE WALL PANELS LESS THAN 48 INCHES IN
ACTUAL LENGTH
 (BRACING METHODS PAR. (b) 3, (b) 4 and (b) 5)

Actual Length of Braced Wall Panel (inches)	Effective Length of Braced Wall Panel (inches)		
	8-foot Wall Height	9-foot Wall Height	10-foot Wall Height
48	48	48	48
42	36	36	N/A
36	27	N/A	N/A

(d) *Braced Wall Panel Location and Amounts.* Braced wall panels shall begin no more than 12.5 feet from each end of a braced wall line per figures 21.25-A and 21.25-B, and shall be located every 25 feet on center. Bracing amounts shall comply with Table 21.25-H for the bracing materials and methods specified under par. (b).

(e) *Braced Wall Lines.* 1. ‘General.’ Maximum spacing between parallel wall lines shall be no more than 35 feet.

2. ‘Exception.’ Spacing between braced wall lines may be increased to 50 feet however, the percentage of wall bracing on the braced wall lines perpendicular to the spacing, must be increased, by multiplying the values in Table 21.25-G by a factor equal to the braced wall line spacing divided by 35 feet, and the length to width ratio for the floor/roof diaphragm as measured between braced wall lines does not exceed 3:1.

3. ‘Offsets.’ Offsets in braced wall lines, out-of-plane of up to 4 feet shall be permitted provided that the total out-to-out offset dimension in any braced wall line is not more than 8 feet per Figure 21.25-C.

4. ‘Variation from story to story.’ Variation in bracing method from story to story is permitted.

5. ‘Variation within a story.’ Variation in bracing method from braced wall line to braced wall line within a story is permitted, except that the continuous sheathing method with wood structural panels shall conform to the additional requirements of par. (9) (c).

**TABLE 21.25-H
MINIMUM REQUIRED BRACING AMOUNTS FOR WALLS**

Wall Supporting:	AMOUNT OF BRACING PER WALL LINE⁴	
	Braced segments shall be located at least every 25-ft o.c. but not less than the following percentages:	
	Wood Structural Panel Sheathing [Sub. (8) (b) 4., (9) (b) &(9) (c)]	Other Methods Permitted [Sub. (8) (b) 1, 2, 3, 5& 6.]
Roof only¹	16%	16% ²
Floor and roof	16%	25% ²
Two Floors and roof	25%	35% ³

¹ The ‘Roof only’ condition also applies to one braced wall line of wood frame construction on the ground floor where all other exterior walls on the ground floor are constructed of masonry or concrete in accordance with s. Comm. 21.18.

² Wood and metal let in bracing exempt from % bracing requirement, but not spacing requirement.

³ Wood and metal let in bracing not permitted as a bracing method.

⁴ Maximum wall heights equal 12 feet. For wall heights over 10 feet, increase percent bracing requirement an additional 20%.

⁵ For continuous sheathing method with wood structural panels, percent requirement may be decreased 10% when openings on the wall line do not exceed 85% of wall height and may be decreased 20% when openings do not exceed 67% of wall height. See Table 21.25-J.

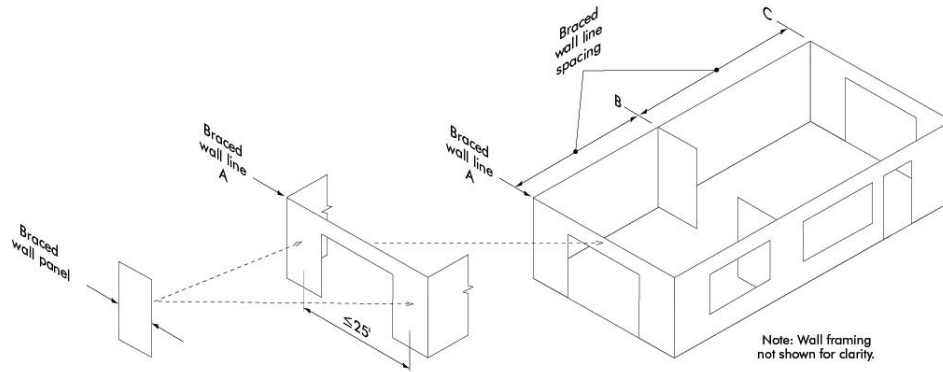

FIGURE 21.25-A
BRACED WALL PANELS AND BRACED WALL LINES

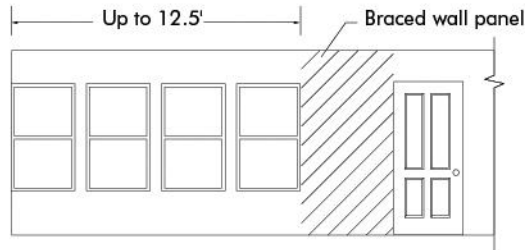

FIGURE 21.25-B
PERMITTED BRACED WALL PANEL DISTANCES
FROM ENDS OF A BRACED WALL LINE

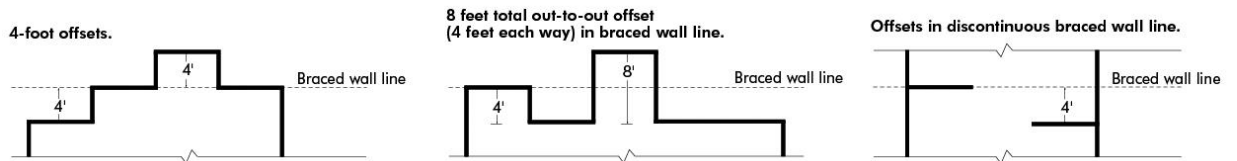

FIGURE 21.25-C
PERMITTED OFFSETS

(f) *Angled Corners.* 1. At corners, braced wall lines may angle out of plane up to 45 degrees with a maximum diagonal length of 8 feet.

2. When determining the percentage of bracing, the length of each braced wall line shall be determined as shown in Figure 21.25-D.

3. The placement of bracing for the braced wall lines shall begin at the point where the braced wall line, which contains the angled wall adjoins the adjacent braced wall line.

Note: This is at Point A as shown in Figure 21.25-D.

4. Where an angled corner is constructed at an angle equal to 45 degrees and the diagonal length is no more than 8 feet in length, the angled wall may be considered as part of either of the adjoining braced wall lines, but not both.

5. Where the diagonal length is greater than 8 feet, it shall be considered its own braced wall line and be braced in accordance with par. (b).

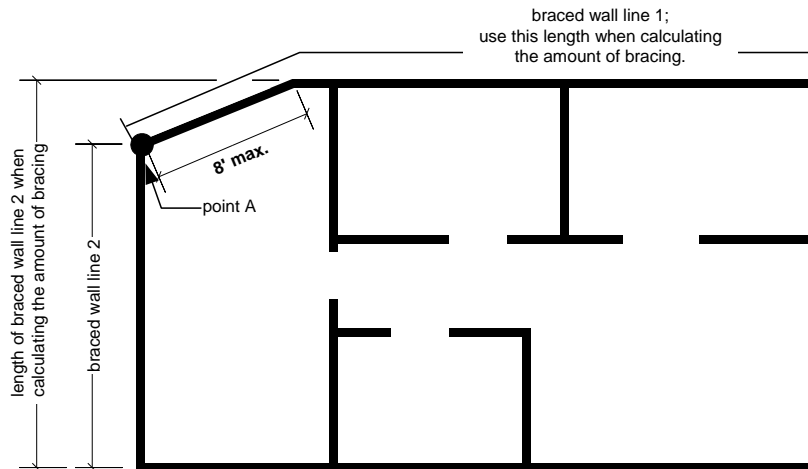

FIGURE 21.25-D
ANGLED CORNERS

(g) *Braced wall panel support.* Braced wall panels shall be supported on floor framing or foundations as follows:

1. Where joists are perpendicular to braced wall lines above or below, blocking shall be provided between the joists at braced wall panel locations to permit fastening of wall plates in accordance with the fastener table in the appendix.

2. Where joists are parallel to braced wall lines above or below, a rim joist or other parallel framing member shall be provided at the wall to permit fastening of wall plates in accordance with the fastener table in the appendix.

3. Braced wall panels shall be permitted to be supported on cantilevered floor joists meeting the cantilever limits of s. Comm 21.22 (6) provided joists are blocked at the nearest

bearing wall location, except such blocking is not required for cantilevers not exceeding 24 inches where a full height rim joist is provided.

4. Elevated post or pier foundations supporting braced wall panels shall be designed in accordance with accepted engineering practice.

(h) *Panel joints.* 1. 'General.' Except as provided under subd. 2., all vertical joints of panel sheathing shall occur over, and be fastened to common studs. Horizontal joints in braced wall panels shall occur over, and be fastened to common blocking of a minimum 1½ inch thickness.

2. 'Exceptions.' a. Blocking at horizontal joints is not required in wall segments that are not counted as braced wall panels.

b. Where the bracing percentage provided is at least twice the minimum percentage required by Table 21.25-H, blocking at horizontal joints is not required in braced wall panels using methods subs. (b) 4., 5. or 6.

(9) ALTERNATIVE BRACING METHODS AND MODIFICATIONS. (a) *General.* As an alternative to the bracing methods under sub. (8), the wall bracing methods in this subsection may also be used.

(b) *Alternate braced wall panels.* 1. 'General.' Alternate braced wall panels constructed in accordance with subd. 2., 3., 4. or 5. may replace each 4 feet of braced wall panel as required under sub. (8) (b). The maximum height and minimum length of each panel shall be in accordance with Table 21.25-I.

2. 'Supporting roof only.' a. In one-story buildings, each panel shall be sheathed on one face with 3/8-inch-minimum-thickness wood structural panel sheathing nailed with 8d common or galvanized box nails in accordance with the fastening table in the appendix and blocked at all wood structural panel sheathing edges.

b. Two anchor bolts installed in accordance with s. Comm 21.18 (1) (c) 3. shall be provided in each panel.

c. Anchor bolts shall be placed 6 to 12 inches from each end of the plate.

d. Each panel end stud shall have a tie-down device fastened to the foundation, capable of providing an uplift capacity in accordance with Table 21.25-I.

e. The tie-down device shall be installed in accordance with the manufacturer's recommendations.

f. The panels shall be supported directly on a foundation or on floor framing supported directly on a foundation, which is continuous across the entire length of the braced wall line.

- g. This foundation shall be reinforced with not less than one number 4 bar at the top and bottom.
- h. When the continuous foundation is required to have a depth greater than 12 inches a minimum 12-inch-by-12-inch continuous footing or turned down slab edge is permitted at door openings in the braced wall line.
- i. This continuous footing or turned down slab edge shall be reinforced with not less than one number 4 bar at the top and bottom.
- j. This reinforcement shall be lapped 15 inches with the reinforcement required in the continuous foundation located directly under the braced wall line.
3. ‘Supporting floor and roof only.’ In the first story of two-story buildings, each braced wall panel shall be in accordance with subd. 1., except that the wood structural panel sheathing edge nailing spacing shall not exceed four inches on center.

**TABLE 21.25-I
MINIMUM LENGTH REQUIREMENTS AND TIE-DOWN FORCES
FOR ALTERNATE BRACED WALL PANELS**

	Height of Braced Wall Panel				
	8 ft.	9 ft.	10 ft.	11 ft.	12 ft.
Sheathed Length	2'-4"	2'-8"	2'-8"	3'-2"	3'-6"
Sub. (9) (b) 2. Tie-down Force (lbs)	1800	1800	1800	2000	2200
Sub. (9) (b) 3. Tie-down Force (lbs)	3000	3000	3000	3300	3600

4. ‘Alternate bracing method with Extended Header over Opening and Tie Downs, supporting a roof only.’
- a. Each panel shall have a length of not less than 16 inches and a height of not more than 10 feet.
- b. Each panel shall be sheathed on one face with a single layer of 3/8-inch-minimum-thickness wood structural panel sheathing nailed with 8d common or galvanized box nails in accordance with Figure 21.25-E.
- c. The wood structural panel sheathing shall extend up over the header and shall be nailed in accordance with Figure 21.25-E.
- d. Glue laminated beams, LVL’s or a built-up header consisting of at least two 2 X 12’s fastened in accordance with the fastener table in the appendix may be used.

- e. A spacer, if used, shall be placed on the side of the built-up beam opposite the wood structural panel sheathing.
- f. The header shall extend between the inside faces of the first full-length outer studs of each panel.
- g. The clear span of the header between the inner studs of each panel shall be not less than 6 feet and not more than 18 feet in length.
- h. A strap with an uplift capacity of not less than 1000 pounds shall fasten the header to the side of the inner studs opposite the sheathing.
- i. One anchor bolt not less than 5/8-inch-diameter, installed in accordance with s. Comm 21.18 (1) (c) 3. shall be provided in the center of each sill plate.
- j. The studs at each end of the panel shall have a tie-down device fastened to the foundation with an uplift capacity of not less than 4,200 pounds.
- k. Where a panel is located on one side of the opening, the header shall extend between the inside face of the first full-length stud of the panel and the bearing studs at the other end of the opening.
- L. The bearing studs shall also have a tie-down device fastened to the foundation with an uplift capacity of not less than 1000 pounds.
- m. The tie-down devices shall be an embedded-strap type, installed in accordance with the manufacturer's recommendations.
- n. The panels shall be supported directly on a foundation, which is continuous across the entire length of the braced wall line.
- o. The foundation shall be reinforced with not less than one number 4 bar top and bottom.
- p. Where the continuous foundation is required to have a depth greater than 12 inches, a minimum 12-inch-by-12-inch continuous footing or turned down slab edge is permitted at door openings in the braced wall line.
- q. This continuous footing or turned down slab edge shall be reinforced with not less than one number 4 bar top and bottom.
- r. This reinforcement shall be lapped not less than 15 inches with the reinforcement required in the continuous foundation located directly under the braced wall line.

5. 'Alternate bracing method with Extended Header Over Opening and Tie Downs, in a wall supporting a floor and roof only.' Each wall panel shall be braced in accordance with subd. 4., except that each panel shall have a length of at least 24 inches.

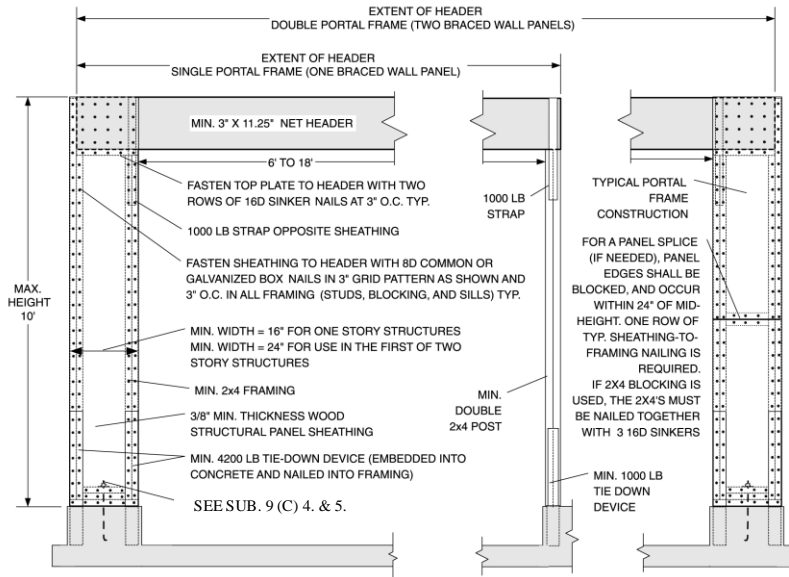

FIGURE 21.25-E
ALTERNATE BRACING METHOD
WITH EXTENDED HEADER AND TIE DOWNS

- (c) *Continuously sheathed braced wall line using wood structural panels.* 1. 'General.'
- a. Continuously sheathed braced wall lines using wood structural panels shall comply with this section.
 - b. Different bracing methods are not permitted within a continuously sheathed braced wall line.
 - c. Other bracing methods prescribed by this code are permitted on other braced wall lines on the same story level or on different story levels of the building.
 2. 'Continuously-sheathed braced wall line requirements.' Continuously-sheathed braced wall lines shall be constructed in accordance with Figure 21.25-F and shall comply with all of the following requirements:
 - a. Structural sheathing shall be applied to all exterior sheathable surfaces of a braced wall line including areas above and below openings.
 - b. Only full-height braced wall panels shall be used for calculating the braced wall percentage in accordance with Table 21.25-H.

c. Exterior corner framing shall be constructed and fastened in accordance with details in Figure 21.25-G.

d. Figures 21.25-H, 21.25-I and 21.25-J provide alternative construction options to Figure 21.25-F, when 2 foot wide wood structural panels are not available at the corners of continuous sheathed wall lines and the return wall lines.

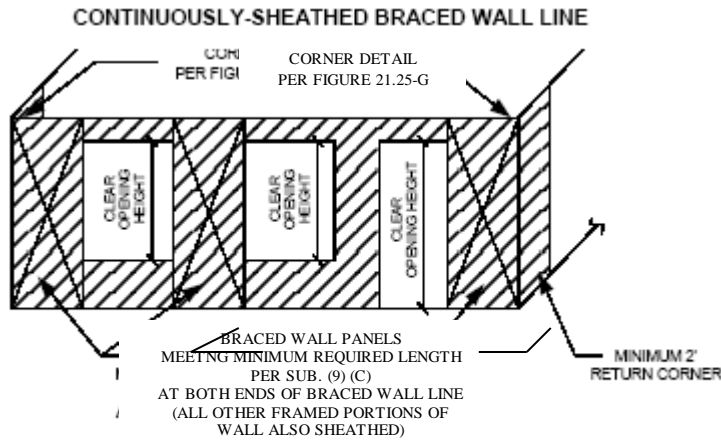

FIGURE 21.25-F
CONTINUOUSLY-SHEATHED BRACED WALL LINE

3. ‘Braced wall panel length.’ In a continuously-sheathed wood structural panel braced wall line, the minimum braced wall panel length shall be permitted to be in accordance with Table 21.25-J.

TABLE 21.25-J
LENGTH REQUIREMENTS FOR BRACED WALL PANELS
IN A CONTINUOUSLY SHEATHED WALL ¹

MINIMUM LENGTH OF BRACED WALL PANEL (inches)			MAXIMUM OPENING CLEAR HEIGHT NEXT TO THE BRACED WALL PANEL (% of wall height)	BRACED WALL PANEL HEIGHT TO WIDTH RATIO
8-foot wall	9-foot wall	10-foot wall		
48	54	60	100%	2:1
32	36	40	85%	3:1
24	27	30	67%	4:1 ²

¹ Interpolation is permitted.

² A 4:1 aspect ratio is permitted for full-height sheathed wall segments on either side of garage openings.

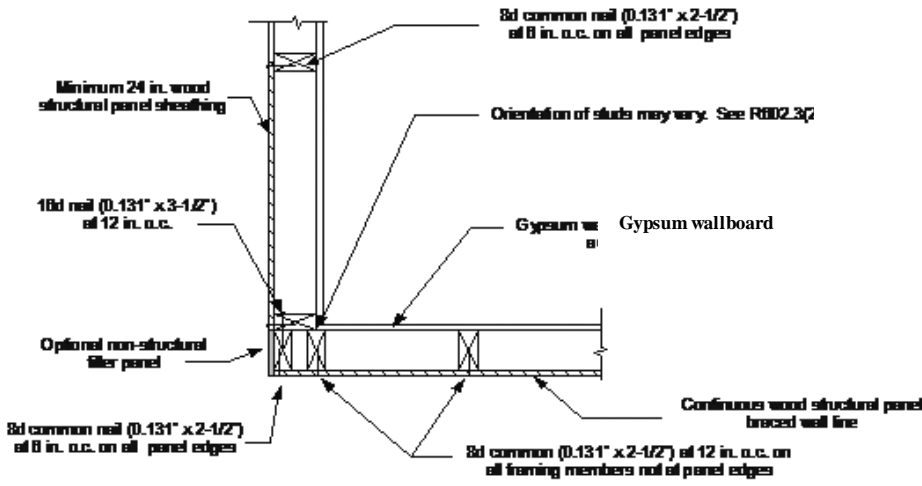

(a) Outside corner detail

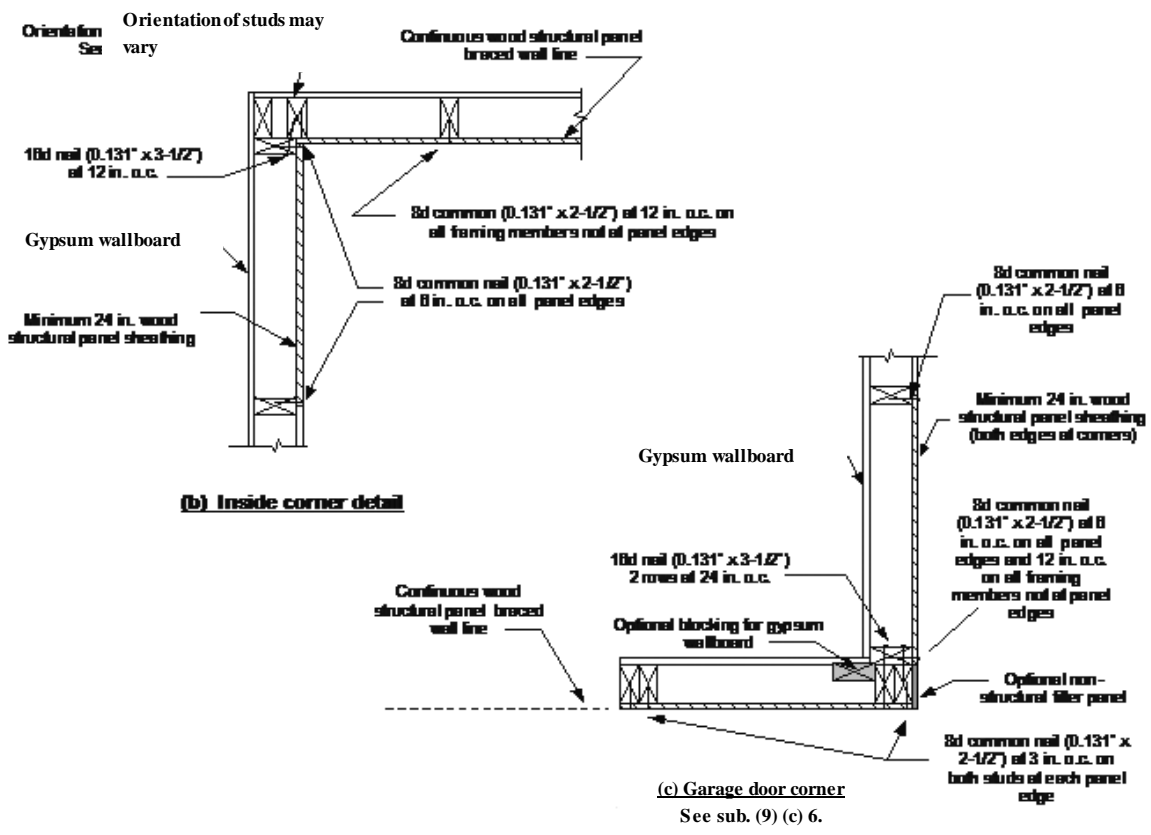

FIGURE 21.25-G
TYPICAL EXTERIOR CORNER FRAMING FOR CONTINUOUS STRUCTURAL PANEL SHEATHING SHOWING REQUIRED STUD-TO-STUD NAILING

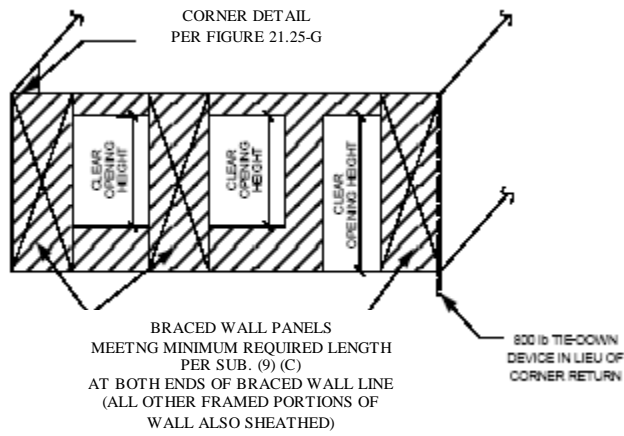

Figure 21.25-H
CONTINUOUSLY-SHEATHED BRACED WALL LINE WITHOUT CORNER RETURN

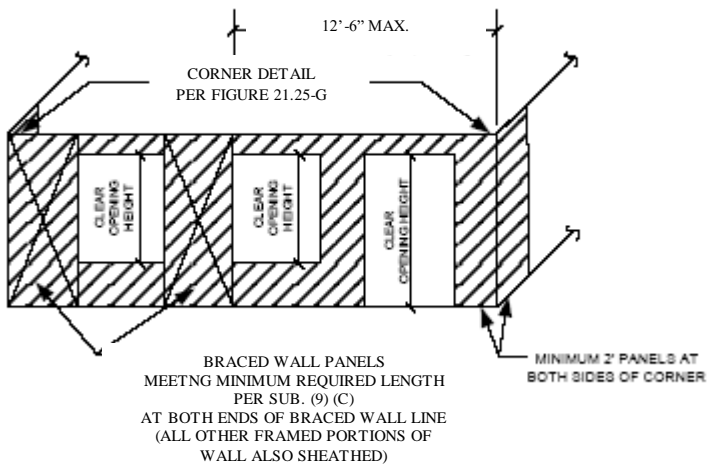

FIGURE 21.25-I
CONTINUOUSLY SHEATHED BRACED WALL LINE-FIRST
BRACED WALL PANEL AWAY FROM END OF WALL LINE WITHOUT TIE DOWN

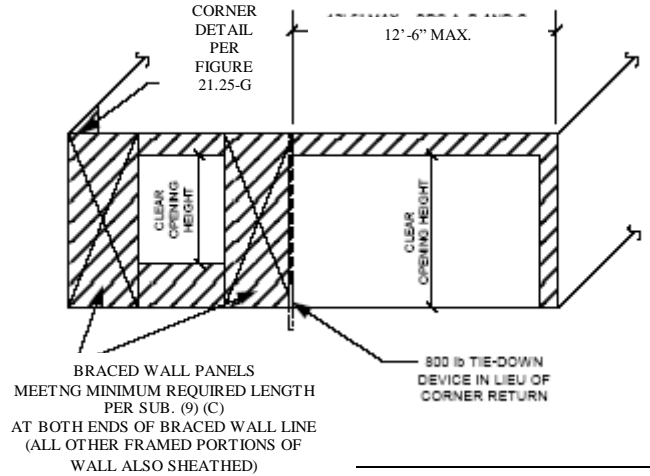

FIGURE 21.25-J
CONTINUOUSLY SHEATHED BRACED WALL LINE – FIRST BRACED WALL PANEL AWAY FROM END OF WALL LINE WITH TIE DOWN

4. ‘Braced wall percentage.’ In addition to bracing percentage adjustments specified elsewhere in this code, the braced wall percentages for method under sub. (8) (b) 4 from Table 21.25-G shall be permitted to be multiplied by a factor in accordance with Table 21.25-K.

TABLE 21.25-K
ADJUSTMENT FACTORS TO THE PERCENTAGE OF REQUIRED BRACING PER WALL LINE – CONTINUOUSLY SHEATHED

ADJUSTMENT BASED ON MAXIMUM WALL CLEAR OPENING HEIGHT:		MULTIPLY PERCENTAGE OF BRACING PER WALL LINE BY:
Continuous wood structural panel sheathing when maximum opening height in wall line does not exceed *	85% of wall height	0.9
	67% of wall height	0.8

* Percentage of bracing for continuous wood structural panel sheathing shall be based on sub. (8) (b) 4 requirements.

5. ‘6:1 aspect ratio continuous structural panel sheathing with extended header.’ a. Wall segments having a maximum 6:1 height to width ratio are permitted only when built in accordance with Figure 21.25-K.

b. The maximum 6:1 height-to-width ratio is based on height being measured from the top of the header to the bottom of the wall segment bottom-plate.

c. For purposes of calculating the percentage of panel bracing required by Table 21.25-H, the length of the braced wall panel shall be the measured length of the full height sheathing segment adjacent to the opening.

d. Corners at the ends of walls using this option shall be constructed in accordance with Figure 21.25- G. Where 6:1 ratio segments are used at the ends of braced wall lines, a 2 foot minimum width wood structural panel must be installed on the corner return as shown in Figure 21.25-F. An 800 lb tie down may be installed in lieu of a 2 foot corner return, as shown in Figure 21.25-H.

e. The reduction factors for continuously braced walls from subd. 4. shall be applied when calculating applicable percentages of wall bracing.

f. The number of wall segments having a maximum 6:1 height to width ratio in a wall line may not exceed four.

g. For purposes of resisting wind pressures acting perpendicular to the wall, the minimum requirements of Figure 21.25-K are sufficient for wind speeds less than 110 mph in exposure category B.

h. For exposure categories C and D, the header to jack stud strap requirements and the number of additional jack studs shall be in accordance with Table 21.25-L.

Note: See Table 21.25-L footnotes for definitions of the exposure categories.

I. 6:1 aspect ratio segments with extended header are permitted over raised wood floors or second story applications, when constructed in accordance with rim board/band joist connection in Figure 21.25-K (b) or (c).

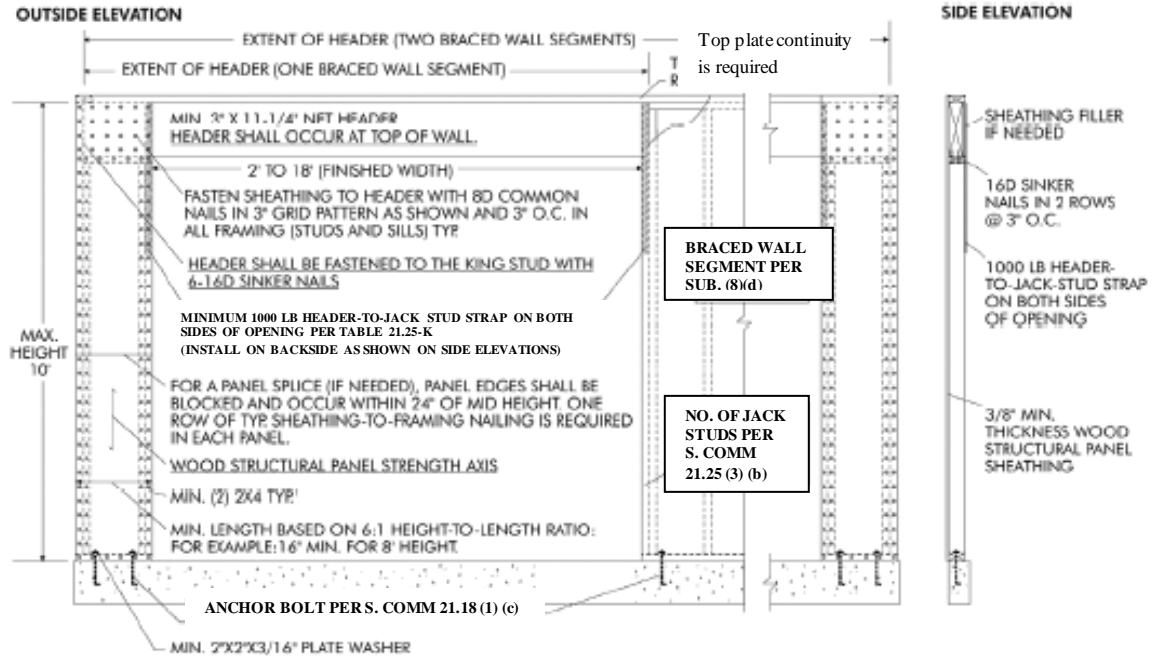

(a)

FOR WIND EXPOSURE CATEGORIES C AND D, ADDITIONAL JACK STUDS MAY BE REQUIRED PER TABLE 21.25-

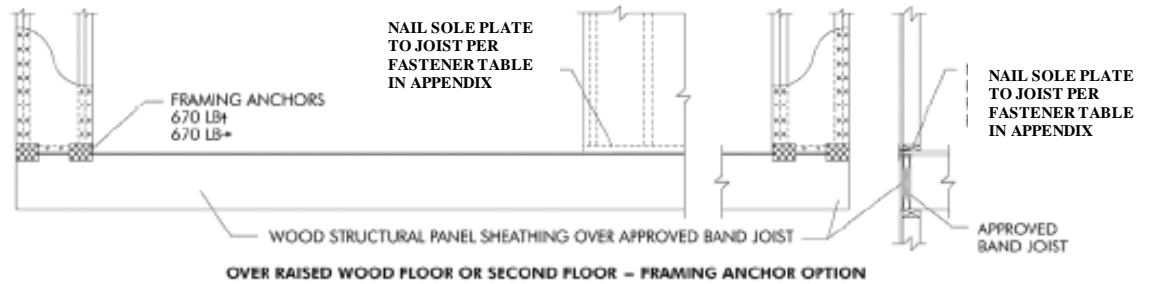

(b)

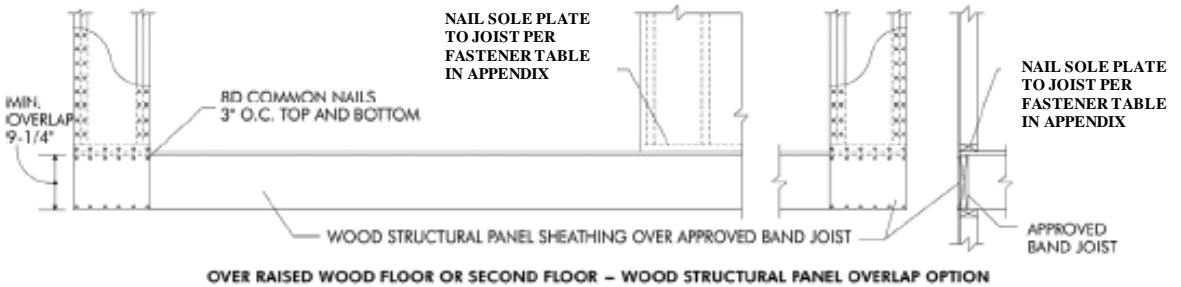

(c)

FIGURE 21.25-K
 6:1 ASPECT RATIO BRACED WALL PANELS USING CONTINUOUS WOOD STRUCTURAL PANEL SHEATHING AND EXTENDED HEADERS

TABLE 21.25-L
HEADER TO JACK STUD STRAP AND THE NUMBER OF ADDITIONAL JACK STUDS REQUIRED FOR RESISTING WIND PRESSURES PERPENDICULAR TO 6:1 ASPECT RATIO WALLS LOCATED IN WIND EXPOSURE CATEGORIES C AND D ^c

Required	Wall Height (ft)	Wind Exposure Category C			Wind Exposure Category D		
		85 mph	90 mph	less than 110 mph	85 mph	90 mph	less than 110 mph
Strap Capacity(lb) ^a	10 and less	1000	1200	2275	1375	1750	3050
Number of additional 2x4 Jack Studs ^b	8	=	=	=	=	=	1
	9	=	=	1	=	1	2
	10	=	1	2	1	2	3

a. If 2x6 framing is used, then the required strap capacity may be multiplied by 0.65, but in no case shall the required strap capacity be less than 1000 lb.

b. If 2x6 framing is used, then no additional framing shall be required.

c. Exposure category B is comprised of urban and suburban areas, wooded areas, or other terrain with numerous closely-spaced obstructions having the size of single-family dwellings or larger. Exposure B shall be assumed unless the site meets the definition of another type exposure.

Exposure category C is comprised of flat open country and grasslands with scattered obstructions, including surface undulations or other irregularities, having heights generally less than 30 feet extending more than 1,500 feet from the building site in any quadrant. This exposure also applies to any building located within Exposure B type terrain where the building is directly adjacent to open areas of Exposure C type terrain in any quadrant for a distance of more than 600 feet.

Exposure category D is comprised of flat, unobstructed areas exposed to wind flowing over open water for a distance of at least 1 mile. This exposure applies only to those buildings and other structures exposed to the wind coming from over the water. Exposure D extends inland from the shoreline a distance of 1,500 feet or 10 times the height of the building or structure, whichever is greater.

SECTION 116. Comm 21.26 (1) is repealed and recreated to read:

Comm 21.26 (1) COLD WEATHER WORK. When ambient air temperature is below 40°F, the cold weather construction procedures under ACI 530.1 shall be followed.

Note: The requirements for cold weather work are in sections 1.8 and 1.8C of the 2005 edition of the ACI standard.

SECTION 117. Comm 21.26 (3) (a) is renumbered Comm 21.26 (3) (b) and Comm 21.26 (3) (intro.) is renumbered Comm 21.26 (3) (a).

SECTION 118. Comm 21.26 (3) (a), as renumbered, is amended to read:

Comm 21.26 (3) TYPES OF MORTAR. (a) *Mortar specifications.* The type of masonry mortar to be used for various kinds of masonry work shall be determined from Table 21.26-A. The mortar shall conform to the property requirements of Table 21.26-B1 and to the requirements of ASTM C-270 or shall be mixed in accordance with the proportions specified in Table 21.26-B.

SECTION 119. Comm 21.26 (4) (b) is amended to read:

Comm 21.26 (4) (b) *Admixtures or mortar colors.* Admixtures or mortar colors shall not be added to the mortar unless the resulting mortar conforms to the ~~requirements of the mortar specifications.~~ ~~Only calcium chloride may be used as an accelerant and shall be limited to 2% by weight of the cement used.~~ ~~Calcium chloride may not be used for any other purpose.~~ Only mineral oxide may be used as mortar color and shall not exceed 10% by weight of the cement used.

SECTION 120. Comm 21.26, Tables 21.26-B and 21.26-B1 are repealed.

SECTION 121. Comm 21.26 (5) (a) is repealed and recreated to read:

Comm 21.26 (5) (a) *Corbels.* Corbels shall be constructed in accordance with ACI 530.

SECTION 122. Comm 21.26 (5) (c) is repealed.

SECTION 123. Comm 21.26 (7) (a) 2. is amended to read:

Comm 21.26 (7) (a) 2. ~~An~~ A minimum one-inch air space shall be provided between the veneer and the sheathing unless a manufactured offset material is used.

SECTION 124. Comm 21.26 (7) (a) 5. to 7. are created to read:

Comm 21.26 (7) (a) 5. Ventilation openings shall be provided at the top of the wall.

Note: The ventilation opening could be other than a weep hole.

Comm 21.26 (7) (a) 6. Studs and sheathing behind masonry veneer shall be covered with material used to construct the water-resistive barrier as required under s. Comm 21.24 (4).

Note: Acceptable water-resistive barrier materials include polymeric-based house wraps and # 15 or greater asphalt-saturated felts that comply with ASTM D 226 for type I felt.

Comm 21.26 (7) (a) 7. Masonry or brick veneer shall be above final exterior grade unless there is through-wall flashing at grade or within two courses above grade.

SECTION 125. Comm 21.26 (7) (c) is created to read:

Comm 21.26 (7) (c) Veneer attachment. Veneers shall be anchored or adhered in accordance with ACI 530 and ACI 530.1.

SECTION 126. Comm 21.26 (8) and Comm 21.26 (12) are repealed and recreated to read:

Comm 21.26 (8) FLASHING. (a) *General.* 1. Flashing shall be installed in accordance with this section to drain any water outward away from structural members, sheathing and insulation.

2. Open joints or weep holes shall be provided in the facing immediately above the flashing at a horizontal spacing not exceeding 2 feet.

3. Flashing shall consist of materials that are durable and permanently UV-resistant such as sheet metal or heavy gauge PVC.

Note: Materials including house wrap, asphalt-impregnated building paper, plastic sheeting, peel-and-stick rubberized sheet material, and light gauge PVC are not acceptable as meeting this requirement.

(b) *Location.* 1. ‘Lintels and chimneys.’ In exterior hollow masonry walls, flashing shall be installed at the backsides of chimneys and at the bottom of the cavity formed by openings such as lintels over doors and windows.

2. ‘Veneer.’ Flashing shall be installed at the bottom of veneer and shall extend over the top of the foundation and up at least 8 inches and be embedded in the backing course.

(c) *Weep holes.* 1. Weep holes may not be placed below final grade.

2. Rope or similar material used to form a weep hole shall be removed as soon as the mortar sets.

3. Weep holes shall be 3/8-inch minimum diameter.

Comm 21.26 (12) JOINTS. Joints in masonry construction shall be constructed in accordance with ACI 530.1.

SECTION 127. Comm 21.27 and 21.28 are repealed and recreated to read:

Comm 21.27 Roof design and framing. (1) STRUCTURAL DESIGN. (a) *General.* Roof and roof-ceiling assemblies shall support all dead loads plus the minimum live loads under par. (c) and s. Comm 21.02.

(b) *Applicability of tables.* The joist and rafter tables in the appendix are valid for roofs with a minimum slope of 3 in 12. Lesser slopes require engineering analysis or shall be provided with a ridge beam.

(c) *Sloped roof snow loads.* Snow loads specified in s. Comm 21.02 (1) (b) 2. may be reduced for roof slopes greater than 30° by multiplying the snow load by C_s . The value of C_s shall be determined by the following: $C_s = 1 - \frac{(a - 30)}{40}$ where a is the slope of the roof expressed in degrees.

Note: A roof pitch of 7 in 12 is equal to 30°.

(2) **LATERAL RESTRAINT OF WALLS.** Provisions shall be taken to absorb the horizontal thrust produced by a sloping roof through the use of wall ties, ceiling joists, beams at the ridge or at the wall or a system designed through structural analysis.

(3) **UPLIFT AND SUCTION FORCES.** (a) *General.* 1. Roofs shall withstand a pressure of at least 20 pounds per square foot acting upward normal to the roof surface.

2. Roof overhangs, eaves, canopies and cornices shall withstand an upward wind pressure of at least 20 pounds per square foot applied to the entire exposed area.

(b) *Anchorage.* 1. Roof framing members spanning more than 6 feet measured from the outermost edge of the roof shall be permanently fastened to the top plate of load bearing walls using engineered clips, straps or hangers.

2. Roof framing members spanning 6 feet or less measured from the outermost edge of the roof shall be permanently fastened to the top plate of load bearing walls using toe-nailing or engineered clips, straps or hangers.

Note: For information on toe nailing, see the fastener schedule table in the appendix.

(4) **ROOF RAFTERS.** (a) *General.* 1. Rafters shall be notched to fit the exterior wall plate and fastened to the wall.

2. Collar ties shall be installed on the upper third of every third pair of abutting roof rafters or every 48 inches, whichever is less.

Note: Collar ties are intended to provide stability to the roof at the ridge. Lateral restraint for the walls must be provided in accordance with sub. (2).

(b) *Ridge boards.* 1. Where rafters meet to form a ridge, the rafters shall be attached to a ridge board.

2. The ridge board shall have a depth at least equal to the length of the cut end of the rafter abutting it.

3. Where all rafters are placed directly opposite each other or are offset at the ridge board by less than the thickness of the rafter, the ridge board shall have a nominal thickness of at least 1 inch.

4. Where one or more rafters are offset at the ridge board by more than the thickness of the rafter, the ridge board shall have a nominal thickness of at least 2 inches.

(c) *Ridge beams*. Rafters shall be attached to ridge beams using engineered clips, straps or hangers or the connection shall be designed through structural analysis.

(d) *Bearing*. The required bearing for wood rafters shall be in accordance with the NDS adopted in Table 20.24-2, except in no case shall the bearing be less than 1½ inches on wood or metal or less than 3 inches on masonry or concrete.

(e) *Ladders*. 1. Overhangs at gable end walls of more than 12 inches shall be provided with ladders which extend into the structure a distance no less than the length of the overhang.

2. The ladders shall be fastened at the wall.

3. The interior end of each ladder shall be attached to a rafter or truss with a hanger.

Note: For the purposes of this section, a ladder is defined as a perpendicular projection extending beyond the face of the wall below.

(5) **CEILING JOISTS**. (a) Ceiling joists shall be nailed to exterior walls and to the ends of rafters.

(b) Ends of ceiling joists shall be lapped at least 3 inches and be fastened either with 3-16d nails or in accordance with the floor joist requirements under s. Comm 21.22 (4) (a) 1. d.

Note: See the fastener table in appendix for a nailing schedule for ceiling joists.

(c) Where ceiling joists are placed at right angles to the rafters, the lookout joist or ties shall be fastened to the parallel ceiling joists or rafters using engineered clips, straps or hangers or the connection shall be designed through structural analysis.

(6) **VALLEY AND HIP RAFTERS**. (a) *Valley rafters*. 1. Where no bearing is provided under valley rafters at the intersection of 2 roof areas, the valley rafters shall be doubled in thickness and shall be at least 2 inches deeper than the required common rafter to permit full bearing at the beveled end.

2. Where ridges are provided at different elevations, vertical support shall be provided for the interior end of the lower ridge board or ridge beam.

(b) *Hip rafters*. Where no bearing is provided under hip rafters, the hip rafters shall be of the same thickness as common rafters and shall be at least 2 inches deeper than required to permit full contact with the jack rafter.

(7) ROOF TRUSSES. (a) Metal plate connected wood roof trusses shall be designed in accordance with TPI 1 and the NDS adopted under s. Comm 20.24.

(b) Truss members shall not be cut, bored or notched, except as allowed under sub. (8) (d).

(c) If connection is provided to stabilize a non-load bearing wall, a slotted expansion joint or clip shall be used.

(8) NOTCHING AND BORING. (a) *General*. 1. Notching and boring of beams or girders is prohibited unless determined through structural analysis.

2. Notching and boring of ceiling joists and rafters shall comply with pars. (b) and (c).

(b) *Notching*. 1. Notches located in the top or bottom of ceiling joists and rafters are prohibited from all of the following:

- a. Having a depth exceeding $\frac{1}{6}$ the depth of the member.
- b. Having a length exceeding $\frac{1}{3}$ the depth of the member.
- c. Being located in the middle $\frac{1}{3}$ of the span of the member.

2. Where ceiling joists or rafters are notched at the ends, the notch may not exceed $\frac{1}{4}$ the depth of the member.

3. Bird mouth cuts may not exceed $\frac{1}{3}$ the depth of the rafter unless the seat cut bears fully on the wall plate.

(c) *Boring*. 1. Holes bored within 2 inches of the top or bottom of ceiling joists or rafters may not be located in the middle $\frac{1}{3}$ of the span of the member.

2. The diameter of a hole may not exceed $\frac{1}{3}$ the depth of the member.

3. A hole may not be bored within 2 inches of a notch or another hole.

4. The distance between adjacent holes may not be less than the diameter of the larger hole.

(d) *Engineered wood products*. Notching or boring of engineered wood products shall be done in accordance with the manufacturer's instructions provided those instructions were developed through structural analysis or product testing.

(9) ROOF SHEATHING, BOARDS AND PLANKING. (a) *Structural sheathing.* The allowable loads and spans for structural sheathing shall be in accordance with the grade stamp on the panel.

(b) *Roof boards.* 1. Where the rafter spacing is 24 inches on center or less, roof boards may be used that have a minimum thickness of 5/8-inch for solid sheathing and 3/4-inch for spaced sheathing.

2. Where the rafter spacing is greater than 24 inches on center, roof boards shall be tongue and groove, at least 1.5 inches thick.

(c) *Roof planks.* 1. Roof planks shall be tongue and groove or splined and at least 2 inches, nominal, in thickness.

2. Planks shall terminate over beams unless the joints are end matched.

3. The planks shall be laid so that no continuous line of joints will occur except at points of support.

4. Planks shall be nailed or fastened to each beam.

Comm 21.28 Weather protection for roofs. (1) GENERAL. (a) All roofs shall be designed and constructed to assure drainage of water.

(b) All fasteners shall be corrosion resistant.

(2) UNDERLAYMENT FOR SHINGLES. Underlayment consisting of number 15 asphalt-impregnated felt paper or equivalent or other type I material that shows no water transmission when tested in accordance with ASTM D 226 or ASTM D 4869 shall be provided under shingles.

Note: Underlayment materials meeting the requirements of ASTM D 1970 meet the performance requirements of this section.

(3) ASPHALT SHINGLES. (a) *General.* 1. Shingles that have a self-sealing adhesive strip shall include a sealant which has an average bond strength of at least 1.5 pounds per 3.75 inches of shingle width, at 32° F.

Note: The department will accept results of testing conducted in accordance with an approved test method for verifying compliance with the sealant uplift resistance required in this paragraph. Information on the applicable test method may be obtained from the department.

2. Each shingle package shall be labeled by the manufacturer to indicate conformance to the applicable ASTM standard for each type of shingle or the exception in par (c).

3. Shingles shall be installed in accordance with the manufacturer's recommendations.

4. Shingles shall have at least 4 fasteners per strip shingle or 2 fasteners per interlocking shingle, unless the manufacturer has other specifications.

5. Shingle head lap shall be at least 2 inches, unless the manufacturer has other specifications.

Note 1: See s. Comm 20.07 (62) for definitions of shingle terms.

Note 2: The Residential Asphalt Roofing Manual can be purchased from the Asphalt Roofing Manufacturers Association at 6000 Executive Boulevard, Suite 201, Rockville, Maryland 20852-3803. This manual contains extensive information on shingles from manufacture through installation, inspection and maintenance. It includes a recommendation that properly driven and applied nails are the preferred fastening system for asphalt shingles.

Note 3: Section Comm 20.04 (2) requires compliance with all parts of this code, including these roofing provisions, for an alteration to any dwelling that is regulated under this code.

(b) *Organic shingles.* Organic asphalt shingles shall conform to ASTM D 225 and the Class C requirements of ASTM E 108, and shall pass the wind resistance test of ASTM D 3161.

(c) *Fiberglass shingles.* Fiberglass asphalt shingles shall conform to ASTM D 3462 except that laminated shingles shall have a tear strength of at least 1450 grams in each ply.

(4) ICE DAM PROTECTION. (a) Shingled or shake roofs that extend over a heated area of a dwelling or attached garage and that have a slope of 4:12 or less shall be provided with ice dam protection in the form of sheet metal or a product labeled as meeting the requirements of ASTM D 1970.

(b) The ice dam protection shall extend at least 30 inches up the roof slope from the roof edge and at least 12 inches up the roof slope beyond the inner face of the exterior wall.

(5) OTHER ROOF COVERINGS. All roof coverings not otherwise addressed in this section shall be installed in accordance with the manufacturer's instructions or a national standard recognized by the department.

(6) REROOFING. New roof coverings may not be installed over existing roof coverings where any of the following conditions exist:

(a) The existing roof or roof covering is water-soaked or has deteriorated such that it is inadequate as a base for additional roofing.

(b) The existing roof is wood shake, slate, clay, cement or asbestos-cement tile.

(c) The existing roof has 2 or more applications of any type of permanent roof covering.

(7) FLASHING. (a) *General.* Flashing shall be installed at the junction of chimneys and roofs, in all valleys, and around all roof openings.

(b) *Flashing of open valleys.* 1. Open valleys shall be flashed with at least No. 28 gauge corrosion-resistant sheet metal, 16 inches wide, or a layer of at least 50-pound roll roofing, 16 inches wide, placed over a layer of number 15 roofing underlayment.

2. Flashing sections shall be overlapped by at least 4 inches.

(c) *Flashing of closed valleys.* Where shingles are laced or woven over the valley, the valley shall be flashed with at least one layer of 50-pound roofing, at least 20 inches wide, over a layer of number 15 roofing underlayment.

(d) *Chimney flashing.* 1. Chimneys shall be flashed and counter-flashed to a height of at least 6 inches.

2. Chimney crickets or saddles shall be installed where the upper side of a chimney is more than 30 inches wide on a sloping roof.

3. The intersection of the cricket and the chimney shall be flashed and counter-flashed to a height of at least 6 inches.

SECTION 128. Comm 21.40 (2) (b) 13. is amended to read:

Comm 21.40 (2) (b) 13. a. Each pier shall be capped with a solid concrete block at least 4 inches thick or a solid wood block having a nominal thickness of at least 2 inches.

b. The cap shall be the same width and length as the top of the pier.

c. The cap shall consist of no more than 2 pieces.

d. Two-piece caps shall be positioned with the joint perpendicular to the main frame.

SECTION 129. Chapter Comm 22 is repealed and recreated to read:

Subchapter I — Scope and Application

Comm 22.01 Scope. (1) This chapter applies to all one- and 2-family dwellings covered by this code that use any amount of non-renewable energy for heat generation.

Note: Non-renewable energy sources used for heat distribution only will not require compliance with this chapter.

Note: The Public Service Commission has rules regulating "non-essential uses" of natural gas, such as snow melting and lighting in ch. PSC 136 of the Wisconsin Administrative Code.

(2) The equipment efficiency standards in this chapter apply to all one- and 2-family dwellings covered by this code that use the respective equipment.

(3) The vapor retarder requirements under s. Comm 22.38 and the moisture control and ventilation requirements under s. Comm 22.39 apply to any dwelling with insulation installed, whether or not the insulation is required under this code.

Comm 22.02 Application. (1) This chapter is not intended to conflict with any safety or health requirements. Where a conflict occurs, the safety and health requirements shall govern.

(2) This chapter allows the designer the option of using various methods to demonstrate compliance with thermal performance requirements. The designer shall identify on the plan submittal form what method or subchapter is being used, and indicate the design criteria and how it is being applied. Unless specifically exempted, all requirements of this chapter apply regardless of the method used.

Subchapter II — Definitions

Comm 22.10 Definitions. (1) “Air-impermeable” means having an air permeance less than or equal to 0.02 L/s-m^2 at a pressure differential of 75 pascals when tested according to ASTM E 2178 or ASTM E 283.

(2) “Conditioned floor area” means the sum of areas of all floors in conditioned space in the structure, including basements, cellars, and intermediate floored levels measured from the exterior faces of exterior walls or from the center line of interior walls, excluding covered walkways, open roofed-over areas, porches, exterior terraces or steps, chimneys, roof overhangs and similar features.

(3) “Conditioned space” means space within the dwelling thermal envelope which is provided with heated air or surfaces to provide a heated space capable of maintaining the temperature of the space to at least 50° F at design conditions.

(4) “Crawl space wall” means the opaque portion of a wall which encloses a crawl space and is partially or totally below grade.

(5) “Dwelling thermal envelope” means the elements of a dwelling with enclosed conditioned space through which thermal energy may be transferred to or from unconditioned space or the exterior.

(6) “Exterior wall area” means the normal projection of the dwelling envelope wall area bounding interior space which is conditioned by an energy-using system including opaque wall, window and door area. Any skylight shaft walls that are 12 inches or more in depth, measured from the ceiling plane to the roof deck, are considered in the area of exterior walls and are not considered part of the roof assembly.

(7) “Heated slab” means a floor slab in which an uninsulated heating element, uninsulated hydronic tubing or uninsulated hot air distribution system is in contact with the slab or placed within the slab or the subgrade.

(8) “HVAC” means heating, ventilating and air conditioning.

(9) “HVAC system” means the equipment, distribution network, and terminals that provide either collectively or individually the processes of heating, ventilating, or air conditioning to a building.

(10) “Infiltration” means the uncontrolled inward air leakage through cracks and interstices in any dwelling element and around windows and doors of a dwelling caused by the pressure effects of wind, and the effect of differences in the indoor and outdoor air density.

(11) “IC-rated” means an electrical fixture tested and listed by an independent testing laboratory as being suitable for installation in a cavity where the fixture may be in direct contact with thermal insulation or combustible materials.

(12) “Mass wall” means a wall of concrete block, concrete, insulated concrete forms, masonry cavity, brick other than brick veneer, earth and solid timber or logs.

(13) “Opaque areas” means all exposed areas of a dwelling envelope which enclose conditioned space except openings for windows, skylights, doors and dwelling service systems.

(14) “Proposed design” means a description of the proposed dwelling used to estimate annual energy use for determining compliance based on total building performance.

(15) “Renewable energy sources” means sources of energy, excluding minerals and petroleum products, derived from incoming solar radiation, trees and other plants, wind, waves and tides, lake or pond thermal differences and from the internal heat of the earth.

(16) “Roof assembly” means all components of the roof and ceiling envelope through which heat flows, thus creating a building transmission heat loss or gain, where such assembly is exposed to outdoor air and encloses a heated space. Any skylight shaft walls less than 12 inches in depth, as measured from the ceiling plane to the roof deck, are considered in the roof assembly and are not considered in the area of exterior walls.

(17) “Sun room” means a one-story structure attached to a dwelling with a glazing area in excess of 40% of the gross area of the structure's exterior walls and roof.

Note: A thermally isolated sun room does not count in the calculation of amount of glazing.

(18) “System” means a combination of central or terminal equipment and their components, controls, accessories, interconnecting means, and terminal devices by which energy is transformed so as to perform a specific function such as, HVAC, water heating or illumination.

(19) “Thermal resistance” or “R-value” means a measure of the ability to retard the flow of heat. The R-value is the reciprocal of thermal transmittance or U-factor expressed as $R = 1/U$.

Note: The higher the R-value of a material, the more difficult it is for heat to be transmitted through the material.

(20) “Thermal transmittance” or “U-factor” means the time rate of heat flow through a body or assembly which is located in between 2 different environments, expressed in $\text{Btu/h} \cdot \text{ft}^2 \cdot ^\circ\text{F}$. The U-factor applies to combinations of different materials used in series along the heat flow path and also to single materials that comprise a dwelling section, including cavity air spaces and air films on both sides of a dwelling element.

Note 1: The lower the U-factor of a material, the more difficult it is for heat to be transmitted through the material.

Note 2: The thermal transmittance is also referred to as the coefficient of heat transfer or the coefficient of heat transmission.

(21) “Thermally isolated” means physically and thermally separated with separate zone or separate equipment controls for space heating.

(22) “Thermostat” means an automatic control device actuated by temperature and designed to be responsive to temperature.

(23) “Ventilation” means the process of supplying or removing air by natural or mechanical means to or from any space. The air may or may not have been conditioned.

(24) “Zone” means a space or group of spaces within a dwelling with heating requirements sufficiently similar so that comfort conditions can be maintained throughout by a single controlling device.

Subchapter III — Insulation Materials and Installation

Comm 22.20 Basic requirements. (1) GENERAL. When available, information and values on thermal properties, performance of building envelope sections and components, and heat transfer shall be obtained from the ASHRAE Handbook of Fundamentals.

(2) COMPUTATION OF R-VALUES. (a) Insulation material used in layers, such as framing cavity insulation and insulating sheathing, shall be summed to compute the component R-value.

(b) The manufacturer’s settled R-value shall be used for blown insulation.

(c) Computed R-values may not include values for air films or for building materials other than insulation materials.

Note: The REScheck program will automatically account for air films and other building materials.

(3) LABORATORY OR FIELD TEST MEASUREMENTS. (a) *General dwelling thermal envelope materials.* When information specified under sub. (1) is not available, or when a different value is claimed, supporting data shall be obtained using one of the following test methods:

a. ASTM C177, Standard test method for steady state heat flux measurements and thermal transmission properties by means of the guarded-hot-plate apparatus.

b. ASTM C335, Standard test method for steady state heat transfer properties of pipe insulation.

c. ASTM C518, Standard test method for steady state thermal transmission properties by means of the heat flow meter apparatus.

d. ASTM C1363, Standard test method for the thermal performance of building materials and envelope assemblies by means of a hot box apparatus.

(b) *Foam plastic insulation.* 1. When information specified under sub. (1) is not available, or when a different value is claimed, foam plastic insulation that uses a gas other than air as the insulating medium shall use laboratory or field tests conducted on representative samples that have been aged for the equivalent of 5 years or until the R-value has stabilized.

2. The tests shall be conducted by an independent third party using the standards listed under par. (a) and shall be submitted for department review and approval in accordance with s. Comm 20.18.

(c) *Concrete masonry units.* Systems using integrally-insulated concrete masonry units shall be evaluated for thermal performance in accordance with one of the following:

1. Default values as approved by the department with no extrapolations or interpolations.

2. Laboratory or field test measurements specified under par (a).

3. The material approval process specified in s. Comm 20.18.

(4) GENERAL INSTALLATION. (a) Materials, equipment and systems shall be identified in a manner that will allow a determination of their compliance with the applicable provisions of this code.

(b) All insulation materials, caulking and weatherstripping, fenestration assemblies, mechanical equipment and systems components, and water-heating equipment and system components shall be installed in accordance with the manufacturer's installation instructions.

(c) Manufacturer's installation instructions shall be available on the job site at the time of inspection.

(d) Roof and ceiling, floor and wall cavity batt or board insulation shall be installed in a manner which will permit inspection of the manufacturer's R-value identification mark.

(5) IDENTIFICATION. (a) A thermal resistance identification mark shall be applied by the manufacturer to each piece of dwelling envelope insulation 12-inches or greater in width.

(b) 1. The thickness of blown-in roof and ceiling insulation shall be identified by thickness markings that are labeled in inches and installed at least one for every 300 square feet through the attic space.

2. The markers shall be affixed to trusses or joists marking the minimum initial installed thickness and minimum settled thickness with numbers a minimum of one-inch in height.

3. Each marker shall face the attic access.

4. The thickness of installed insulation shall meet or exceed the minimum initial installed thickness shown by the marker.

(6) CERTIFICATE. (a) A permanent certificate shall be posted on or immediately adjacent to the electrical distribution panel.

(b) The certificate shall be completed by the owner, builder or insulation installer.

(c) The certificate shall list at least the following information:

1. The predominant R-values of insulation installed in or on ceilings or roofs, walls, foundation walls, slabs and any heating ducts that are outside the thermal envelope.

2. The U-factors of all windows, skylights and doors.

(d) If using the REScheck or REM/Rate software programs, the certificate shall be printed from that program.

Comm 22.21 Protection of insulation. (1) BLANKET INSULATION. Insulating blankets or batts shall be held in place with a covering or other means of mechanical or adhesive fastening.

Note: If the insulation is on a below-grade wall, s. Comm 22.08 (3) may prohibit the use of vapor retarder material used as the covering.

(2) WIND WASH PROTECTION. (a) Except as provided under s. Comm 22.39 (4) for cathedral ceilings, all air-permeable insulation materials installed in any position other than horizontal, shall be covered on the cold-in-winter side with a permanently attached material of low air permeability to maintain the R-value of the insulation.

Note: Suitable materials for this purpose include house wrap permanently attached with batten strips, asphalt-impregnated felt or tar paper, plywood, oriented strand board or OSB, siding material, rigid insulation sheathing, etc.

(b) If non-rigid sheet material is used, it shall be water vapor permeable.

Note: Water vapor permeable materials for this purpose include house wrap permanently attached with batten strips and asphalt-impregnated felt or tar paper.

(3) FOAM PLASTIC INSULATION. (a) Exterior foam plastic insulation shall be protected from physical damage and damage from ultraviolet light with a permanent, opaque, weather-resistant covering or coating.

(b) The protective covering shall cover the exposed exterior insulation and extend a minimum of 6 inches below grade.

Note: For interior applications, a thermal barrier may be required under s. Comm 21.11.

Subchapter IV Dwelling Thermal Envelope

Comm 22.30 General Design Requirements. (1) GENERAL. Dwelling thermal envelope insulation amounts and details shall be determined using one of the methods described in this subchapter.

(2) INFILTRATION. (a) Infiltration for heating design loads shall be calculated based on a maximum of 0.5 air change per hour in the heated space.

(b) 1. If the proposed design takes credit for a reduced air change per hour level, documentation of the measures providing the reduction or the results of a post-construction blower door test conducted in accordance ASTM E 779 shall be provided to the department.

2. The minimum air change per hour rate may not be less than 0.2, unless mechanical ventilation is provided.

(3) BASEMENTS AND CRAWL SPACES. Where basement and crawl space walls are part of the dwelling thermal envelope, their R-values and U-factors shall be based on the wall components. Adjacent soil may not be considered in the determination.

(4) GARAGES. (a) Except as provided under par. (b), a garage may not be provided with any supplemental heat unless all of the following conditions are met:

Note: Because of the scope of this chapter, the requirements under this subsection apply only to heat generated from non-renewable sources.

1. The dwelling shall be thermally isolated from the garage.

2. The garage floor, ceiling and walls shall be provided with a vapor retarder in accordance with s. Comm 22.38.

3. All building elements shall meet the requirements of s. Comm 22.31.

(b) The thermal envelope requirements under par. (a) are not required if all of the following conditions are met:

1. The thermostat is permanently limited to a maximum of 50°F.

2. Heating equipment is either separate from the dwelling unit equipment or installed as a separate zone.

3. Separate heating equipment shall be sized to provide a maximum indoor temperature of 50°F.

(5) MASONRY VENEER. When insulation is placed on the exterior of a foundation supporting a masonry veneer exterior, the horizontal foundation surface supporting the veneer is not required to be insulated to satisfy the foundation insulation requirement.

Comm 22.31 Prescriptive insulation and fenestration criteria. (1)
 REQUIREMENTS. (a) Except as specifically provided under this subchapter, dwellings using the prescriptive method shall meet the requirements of Table 22.31-1 or 22.31-2.

(b) In Tables 22.31-1 and 22.31-2, zone 2 consists of the following 15 northern counties: Ashland, Bayfield, Burnett, Douglas, Florence, Forest, Iron, Langlade, Lincoln, Oneida, Price, Sawyer, Taylor, Vilas and Washburn. Zone 1 consists of all other counties not included in zone 2.

**TABLE 22.31-1
 INSULATION AND FENESTRATION REQUIREMENTS BY COMPONENT ^a**

Zone	Fenestration U-Factor	Skylight U-Factor	Ceiling R-Value	Wood Frame Wall R-Value	Mass Wall R-Value	Floor R-Value	Basement or Crawl Space Wall R-Value ^b	Heated Slab R-Value ^c	Unheated Slab R-Value ^d
1	0.35	0.60	49 ^e	19 ^f or 13+5 ^g	15	30 ^h	10/13	10/15	10
2	0.35	0.60	49 ^e	21 ^f	19	30 ^h	10/13	10/15	10

a R-values are minimums. U-factors are maximums.

b The first R-value applies to continuous insulation. The second R-value applies to framing cavity insulation. Either insulation meets the requirement.

c The first R-value applies under the entire slab, regardless of depth below grade. The second R-value applies to the slab edge. Slab edge insulation shall extend downward from the top of the slab for a minimum of 48 inches or downward to at least the bottom of the slab and then horizontally to the interior or exterior for a minimum total distance of 48 inches.

d The R-value applies to any slab, the bottom of which is less than 12 inches below adjacent grade. Also, see s. Comm 21.16 for protection against frost for slabs with supports less than 4 feet below grade.

e See s. Comm 22.32 (1) for application and permitted reduced R-value.

f R-19 and R-21 may be compressed into a 2X6 cavity.

- g “13+5” means R-13 cavity insulation plus R-5 insulated sheathing. If structural sheathing covers 25% or less of the exterior, insulating sheathing is not required where structural sheathing is used. If structural sheathing covers more than 25% of the exterior, structural sheathing shall be covered with insulated sheathing of at least R-2.
- h. Or insulation sufficient to fill the framing cavity with a minimum of R-19.

**TABLE 22.31-2
EQUIVALENT U-FACTORS**

Zone	Fenestration U-Factor	Skylight U-Factor	Ceiling U-Factor	Wood Frame Wall U-Factor	Mass Wall U-Factor	Floor U-Factor	Basement Wall U-Factor	Crawlspace U-Factor
1	0.35	0.60	0.026	0.060	0.060	0.033	0.065	0.065
2	0.35	0.60	0.026	0.057	0.057	0.033	0.065	0.065

(2) THERMAL ENVELOPE. (a) *General*. If the total dwelling thermal envelope UA is less than or equal to the total UA resulting from using the U -factors in Table 22.31-2 multiplied by the same assembly area as in the proposed building, the dwelling is in compliance with this chapter. The UA calculation shall be done using a method consistent with the ASHRAE Handbook of Fundamentals and shall include the thermal bridging effects of framing materials.

Note: UA is equal to the product of the U -factor times the assembly area.

Note: REScheck and REM/Rate are acceptable software programs for determining compliance with this section.

(b) *Software edition*. If the REScheck software program is used to show compliance with this section, the version shall be 4.1.0, or later.

Note: Any version of REScheck with a beginning number of 3 or smaller will not support the requirements of this code.

(3) APPLIANCE EFFICIENCY. (a) Except as allowed under par. (b) and s. Comm 22.46, oil-fired and gas-fired furnaces and boilers shall meet the minimum efficiency requirements in Table 22.31-3.

(b) In new construction, an oil-fired or gas-fired furnace or boiler meeting the federal efficiency standard but not the requirements of Table 22.31-3 may be installed if the dwelling thermal envelope requirements of Table 22.31-4 are met.

**TABLE 22.31-3
WARM AIR FURNACES AND BOILERS, MINIMUM EFFICIENCY REQUIREMENTS**

Equipment Type	Minimum Efficiency	Test Procedure
Natural gas and propane furnaces	90% AFUE	DOE 10 CFR Part 430 or ANSI Z21.47
Natural gas and propane hot water boilers	90% AFUE	DOE 10 CFR Part 430
Oil-fired furnaces	83% AFUE	DOE 10 CFR Part 430 or UL 727
Oil-fired hot water boilers	84% AFUE	DOE 10 CFR Part 430

**TABLE 22.31-4
COMPONENT DWELLING THERMAL ENVELOPE REQUIREMENTS FOR
DWELLINGS USING LOWER EFFICIENCY APPLIANCES ^a**

Fenestration U-Factor	Skylight U-Factor	Ceiling R-Value	Wood Frame Wall R-Value	Mass Wall R-Value	Floor R-Value	Basement or Crawl Space Wall R-Value ^b	Heated Slab R-Value ^c	Unheated Slab R-Value ^d
0.30	0.60	49 ^e	21 ^f or 19+5 ^g	19	30 ^h	15/19	10/20	15
Equivalent U-factors								
0.30	0.60	0.26	0.057	0.057	0.033	0.045	0.033	0.047

a R-Values are minimums. U-Factors are maximums.

b The first R-value applies to continuous insulation. The second R-value applies to framing cavity insulation.

c The first R-value applies under the entire slab, regardless of depth below grade. The second R-value applies to the slab edge. Slab edge insulation shall extend downward from the top of the slab for a minimum of 48 inches or downward to at least the bottom of the slab and then horizontally to the interior or exterior for a minimum total distance of 48 inches.

d The R-value applies to any slab, the bottom of which is less than 12 inches below adjacent grade. Also, see s. Comm 21.16 for protection against frost for slabs with supports less than 4 feet below grade.

e See s. Comm 22.32 (1) for application and permitted reduced R-value.

f R-21 may be compressed into a 2X6 cavity.

g "19+5" means R-19 cavity insulation plus R-5 insulated sheathing. If structural sheathing covers 25% or less of the exterior, insulating sheathing is not required where structural sheathing is used. If structural sheathing covers more than 25% of the exterior, structural sheathing shall be covered with insulated sheathing of at least R-2.

h Or insulation sufficient to fill the framing cavity with a minimum of R-19.

Comm 22.32 Specific insulation requirements. (1) CEILINGS WITH ATTIC SPACES. R-38 will satisfy the ceiling R-value requirement for a dwelling where the full height of uncompressed R-38 insulation extends over the wall top plate at the eaves.

(2) CEILINGS WITHOUT ATTIC SPACES. Where the design of the roof or ceiling assembly does not allow sufficient space for the required R-49 insulation, the minimum required insulation for the roof or ceiling assembly shall be R-30. This reduction of insulation shall be limited to 500 square feet of ceiling area.

(3) MASS WALLS. (a) The requirements of Table 22.31-1 are applicable in a mass wall where at least 50 percent of the required insulation R-value is on the exterior of, or integral to, the wall.

(b) Mass walls that do not meet the specifications under par. (a) for insulation placement shall meet the wood frame wall insulation requirements of Table 22.31-1.

(4) STEEL-FRAME CEILINGS, WALLS AND FLOORS. (a) Steel-frame ceilings, walls and floors shall meet the insulation requirements of Table 22.32 or shall meet the U-factor requirements in Table 22.31-2.

(b) The calculation of the U-factor for a steel-frame envelope assembly shall use a series-parallel path calculation method.

**TABLE 22.32
STEEL-FRAME CEILING, WALL AND FLOOR INSULATION R –VALUES**

WOOD FRAME R -VALUE REQUIREMENT	COLD-FORMED STEEL EQUIVALENT R -VALUE ^a
Steel Truss Ceilings ^b	
R-30	R - 38 or R - 30 + 3 or R - 26 + 5
R-38	R - 49 or R - 38 + 3
R-49	R-38+5
Steel Joist Ceilings ^b	
R-30	R - 38 in 2 x 4 or 2 x 6 or 2 x 8 R - 49 in any framing
R-38	R - 49 in 2 x 4 or 2 x 6 or 2 x 8 or 2 x 10
Steel Framed Wall	
R-13	R - 13 + 5 or R - 15 + 4 or R - 21 + 3
R-19	R - 13 + 9 or R - 19 + 8 or R - 25 + 7
R-21	R - 13 + 10 or R - 19 + 9 or R - 25 + 8
Steel Joist Floor	
R-13	R - 19 in 2 x 6 R - 19 + 6 in 2 x 8 or 2 x 10
R-19	R - 19 + 6 in 2 x 6 R - 19 + 12 in 2 x 8 or 2 x 10

a Cavity insulation *R*-value is listed first, followed by continuous insulation *R*-value.

b Insulation exceeding the height of the framing shall cover the framing.

(5) FLOORS. Floor insulation shall be installed to maintain permanent contact with the underside of the subfloor decking.

(6) BASEMENT WALLS. (a) Walls associated with conditioned basements shall be insulated from the top of the basement wall down to the basement floor.

(b) Walls associated with unconditioned basements shall meet the requirement in par. (a) unless the floor overhead is insulated in accordance with Table 22.31-1.

(c) Where the total basement wall area is less than 50 percent below grade, the entire wall area, including the below-grade portion, is included as part of the area of exterior walls.

(7) BOX SILL AND RIM JOIST SPACES. Box sills and joist spaces at outside walls shall be insulated to the required wall *R*-value with air-impermeable insulation that is sealed on all sides to all framing members and the foundation, or with air-permeable insulation held in place as required under s. Comm 22.21 (1).

(8) OVERHANG JOIST SPACES. (a) Joist spaces that extend beyond exterior walls shall be insulated with an *R*-value of 30 or higher with insulation that completely fills the cavity including over the top of the exterior wall supporting the joists.

(b) The joist space insulation shall be air sealed either by using an air-impermeable insulation that is sealed to all framing members or by covering the insulation with a rigid material that is caulked or sealed to all framing members.

(c) If piping that is subject to freezing is located in the joist space, additional insulation shall be provided on the unconditioned side of the space.

(9) WALL INSULATION. Except for closed-cell sprayed foam, wall insulation shall completely fill the wall cavity.

Comm 22.33 Slab floors. (1) HEATED OR UNHEATED SLABS. Any slab floor, the bottom of which is less than 12 inches below adjacent grade, shall be insulated in accordance with Table 22.31-1 or Table 22.31-4.

(2) HEATED SLABS. In addition to meeting the requirement under sub. (1), if applicable, heated slabs of any depth below grade shall meet the R-value requirement in accordance with Table 22.31-1 or Table 22.31-4.

(3) DETAILS. (a) The top edge of insulation installed between the exterior wall and the edge of the interior slab may be cut at a 45 degree angle away from the exterior wall.

(b) Horizontal insulation extending outside of the foundation shall be covered by soil a minimum of 10 inches thick or by pavement.

Comm 22.34 Crawl spaces. (1) FROST PROTECTION. If the bottom of the crawl space serving as the dwelling foundation is less than 48 inches below adjacent grade, the foundation shall be frost protected in accordance with Table 22.31-1 for frost protected slabs.

(2) VAPOR RETARDER. Any exposed earth in crawl spaces shall be covered with a continuous vapor retarder.

(b) All decayable organic material, including topsoil, shall be removed from crawl space floors prior to placing the vapor retarder.

(c) All joints of the vapor retarder shall overlap by 6 inches and be sealed or taped.

(d) The edges of the vapor retarder shall extend at least 6 inches up the foundation wall and shall be attached to the foundation wall.

(3) UNINSULATED CRAWL SPACES. (a) For crawl spaces that are outside of the thermal envelope, ventilation openings equal to at least 1/1500 of the floor space shall be provided.

(b) At least 50% of the ventilating area shall be provided at opposite sides of the crawl space or as far apart as possible.

(c) The floor above the crawl space shall be insulated in accordance with Table 22.31-1.

(4) INSULATED CRAWL SPACES. (a) As an alternative to insulating floors over unheated crawl spaces, crawl space walls shall be insulated in accordance with Table 22.31-1.

(b) Crawl space wall insulation shall be permanently fastened to the wall and shall extend the entire height of the wall.

(c) The crawl space may not be vented to the outside unless the floor above is insulated in accordance with Table 22.31-1.

Comm 22.35 Thermally isolated sunrooms. (1) The minimum opaque ceiling insulation R -value shall be R-24. The minimum opaque wall R -value shall be R-13.

(2) The maximum fenestration U -factor shall be 0.50 and the maximum skylight U -factor shall be 0.75.

(3) New walls, windows and doors separating a sunroom from conditioned space shall meet the building thermal envelope requirements.

(4) The temperature in the conditioned space shall be controlled as a separate zone or shall use separate heating equipment.

(5) Glazing in a thermally-isolated sunroom is not considered to be in the dwelling thermal envelope.

Comm 22.36 Fenestration. (1) AVERAGE U-FACTORS. An area-weighted average of fenestration products may be used to satisfy the U-factor requirements.

(2) MAXIMUM FENESTRATION U-FACTOR. The area weighted average maximum fenestration U-factor permitted using trade offs from s. Comm 22.31 (2) or subchapter VI shall be 0.40 for vertical fenestration, and 0.75 for skylights.

(3) GLAZED FENESTRATION EXEMPTION. Up to 15 square feet of glazed fenestration per dwelling unit may be exempt from U-factor requirements of this chapter.

(4) OPAQUE DOOR EXEMPTION. One opaque door assembly is exempted from the U -factor requirements of this chapter.

(5) REPLACEMENT FENESTRATION. Where an existing fenestration unit is replaced with a new fenestration unit, including sash and glazing, the replacement unit shall meet the U -factor requirements of this chapter.

(6) CERTIFIED PRODUCTS. Except as provided in sub. (7), fenestration rating, certification and labeling of U-factors for windows, doors and skylights shall be in accordance with NFRC 100.

(7) DEFAULT VALUES. When a manufacturer has not determined product U-factor in accordance with NFRC 100, U-factors shall be determined by assigning a default value in accordance with Tables 22.36-1 and 22.36-2. Where a composite of materials of two different product types is used, the product shall be assigned the higher U-factor.

**TABLE 22.36-1
U-FACTOR DEFAULT TABLE
FOR WINDOWS, GLAZED DOORS AND SKYLIGHTS^a**

	Single Glazed	Double Glazed
<u>Metal without Thermal Break</u>		
Operable	1.27	0.87
Fixed	1.13	0.69
Door	1.26	0.80
Skylight	1.98	1.31
Site-assembled Skylight	1.36	0.82
<u>Metal with Thermal Break</u>		
Operable	1.08	0.65
Fixed	1.07	0.63
Door	1.10	0.66
Skylight	1.89	1.11
Site-assembled Skylight	1.25	0.70
<u>Vinyl or Metal-Clad Wood</u>		
Operable	0.90	0.57
Fixed	0.98	0.56
Door	0.99	0.57
Skylight	1.75	1.05
<u>Wood or Fiberglass</u>		
Operable	0.89	0.55
Fixed	0.98	0.56
Door	0.98	0.56
Skylight	1.47	0.84

^a Glass block assemblies shall have a default value of 0.60.

**TABLE 22.36-2
U-FACTOR DEFAULT TABLE FOR NON-GLAZED DOORS**

STEEL DOORS (1-3/4 inches thick)	<u>With Foam Core</u>	<u>Without Foam Core</u>
	0.35	0.60
WOOD DOORS (1-3/4 inches thick)	<u>Without Storm Door</u>	<u>With Storm Door</u>
Panel with 7/16-inch panels	0.54	0.36
Hollowcore flush	0.46	0.32
Panel with 1-1/8-inch panels	0.39	0.28
Solid core flush	0.40	0.26

Comm 22.37 Air leakage. (1) GENERAL. The requirements of this section apply to those components that separate interior conditioned space from a garage or an unconditioned space.

(2) WINDOW AND DOOR ASSEMBLIES. (a) *General.* Except as specified in par. (b), windows, skylights and sliding glass doors shall have an air infiltration rate of no more than 0.3 cfm per square foot, and swinging doors no more than 0.5 cfm per square foot, when tested according to NFRC 400 or AAMA/WDMA/CSA 101/I.S.2/A440 by an accredited, independent laboratory and listed and labeled by the manufacturer.

(b) *Exception.* Site-constructed doors and windows shall be sealed with gasketing or weatherstripping or shall be covered with a storm door or storm window.

(3) JOINT AND PENETRATION SEALING. (a) Exterior joints, seams or penetrations in the dwelling envelope, that are sources of air leakage, shall be sealed with durable caulking materials, closed with gasketing systems, taped, or covered with water-vapor-permeable house wrap. Joints to be treated include all of the following:

1. Openings, cracks and joints between wall cavities and window or door frames.
2. Between separate wall assemblies or their sill-plates and foundations.
3. Between walls, roof, ceilings or attic ceiling seals, and between separate wall panel assemblies, including between interior and exterior walls.
4. Penetrations of utility services through walls, floor and roof assemblies, and penetrations through top and bottom wall plates.

(b) Sealing shall be provided at the attic and crawl space panels, at recessed lights and around all plumbing and electrical penetrations, where these openings are located in the dwelling thermal envelope.

(c) The sealing methods between dissimilar materials shall allow for differential expansion and contraction.

(4) RECESSED LIGHTING. When installed in the dwelling envelope, recessed lighting fixtures shall be sealed to limit air leakage between conditioned and unconditioned spaces by one of the following means:

(a) The fixture shall be IC-rated and labeled with enclosures that are sealed or gasketed to prevent air leakage to the ceiling cavity or unconditioned space.

(b) The fixture shall be IC-rated and labeled as meeting ASTM E 283 when tested at 1.57 psi pressure differential with no more than 2.0 cfm of air movement from the conditioned space to the ceiling cavity.

(c) 1. The fixture shall be located inside an airtight sealed box with clearances of at least 0.5 inch from combustible material and 3 inches from insulation.

2. If the fixture is non-IC-rated, the box shall be constructed of noncombustible material that does not readily conduct heat.

Note: Cement board meets the requirements of this section. Drywall and metal do not.

(5) FAN HOUSINGS. Gaps between a fan housing and a ceiling or wall that could result in air leaks shall be gasketed, sealed or caulked.

Comm 22.38 Vapor retarders. (1) GENERAL. (a) *Definition.* Under this section, a vapor retarder is a material with no intrinsic thermal or structural properties that has a rating of 1.0 perm or less when tested in accordance with ASTM standard E 96, Procedure A.

(b) *Continuity.* The vapor retarder shall be continuous. All joints in a vapor retarder consisting of sheet material shall be overlapped 6 inches and taped or sealed. Rips, punctures and voids in the vapor retarder shall be patched with vapor retarder materials and taped or sealed.

(2) FRAME ASSEMBLIES. (a) *General.* Except as provided under par. (c), all frame walls, frame floors and frame ceilings that comprise the thermal envelope, shall have a vapor retarder installed on the warm-in-winter side of the thermal insulation.

(b) *Coverage.* The vapor retarder shall cover the exposed insulation and the interior face of the framing.

(c) *Exceptions.* 1. Where the vapor retarder is omitted, as allowed under subds. 2. to 4., all sources of air leakage, such as between double top or bottom plates or between double studs, shall be caulked or sealed.

2. No vapor retarder is required in the box sill.

3. No vapor retarder is required where batt insulation is provided with foil or kraft paper backing on the warm-in-winter side and the nailing tabs are tightly fastened to the warm-in-winter face of the framing members.

4. No vapor retarder is required over cavities that are insulated solely with spray-applied foam unless required by the foam manufacturer.

Note: This requirement does not require the cavity to be completely filled. It only requires that the total required R-value come from the foam, including any exterior foam sheathing, and no other insulation material is present in the cavity.

(3) CONCRETE FLOORS. (a) Except as allowed under par. (e), a vapor retarder shall be installed directly under the concrete floor slab or under the base course of concrete floor slabs.

(b) Vapor retarder material shall be at least 6 mils in thickness or shall be a reinforced material.

(c) Joints in the vapor retarder shall be overlapped at least 6 inches and taped or sealed.

(d) The edges of the vapor retarder shall extend up the edges of the slab at least to the top of the slab.

(e) A vapor retarder is not required under the slab of an unconditioned attached garage.

(4) CONCRETE OR MASONRY BASEMENT WALLS. A non-rigid sheet vapor retarder with a perm rating of 0.1 or less is prohibited in all of the following locations:

(a) On a concrete or masonry wall which is below grade to any extent.

(b) On an insulated frame wall constructed in front of a concrete or masonry wall which is below grade to any extent.

Comm 22.39 Ventilation and moisture control. (1) GENERAL. Design and construction shall prevent deterioration from moisture condensation and ice damming.

(2) VENTED ATTICS. (a) 1. Except as allowed under subd. 6., where air-permeable ceiling or attic insulation is installed in a horizontal position, ventilation shall be provided above the insulation in accordance with this paragraph.

2. At least 50% of the net free ventilating area shall be distributed at the high sides of the roof.

3. The remainder of the net free ventilating area shall be distributed in the lower half of the roof or attic area.

4. If more than 50%, but less than 75% of the net free ventilating area is provided at the high sides of the roof, the total net free ventilating area shall be a minimum of 1/300 of the horizontal area of the ceiling.

5. If 75% or more of the net free ventilating area is provided at the upper sides of the roof, the total net free ventilating area shall be at least 1/150 of the horizontal area of the ceiling.

6. Ventilation is not required for separated roof areas, such as dormers, bump-outs or bays that cover a floor area of 40 ft² or less.

(b) Engineered systems that provide equivalent ventilation to that required under this subsection may be used.

(c) Insulation shall not block the free flow of air.

(3) CONDITIONED ATTICS. Attic spaces are not required to be vented where air-impermeable insulation is attached directly to the underside of the roof deck and all of the following conditions are met:

(a) No interior vapor retarders are installed between the living space and the conditioned attic.

(b) The temperature in the attic space is maintained high enough to prevent any moisture condensation on the insulation.

Note: Maintaining the interior surface temperature of the insulation at or above the dew point temperature of the interior air will minimize condensation. Maintaining at least 45°F on the surface of the insulation will minimize condensation on the surface when the interior air temperature is 70°F and the interior relative humidity is 45%.

(4) CATHEDRAL CEILINGS. Air-permeable insulation in a cathedral ceiling assembly shall fill the entire cavity space unless an air barrier separates the top of the insulation from the ventilation space.

(5) MECHANICAL VENTILATION. Outdoor air intakes and exhausts shall have automatic or gravity dampers that close when the ventilation system is not operating.

(6) CLOTHES DRYERS. Clothes dryers shall be vented to the outside of the structure.

Note: See s. Comm 23.14 for vent material requirements.

Subchapter V - Systems

Comm 22.40 Indoor temperatures and equipment sizing. (1) GENERAL. The indoor temperatures listed under sub. (2) shall be used to determine the total dwelling heat loss and to select the size of the of the heating equipment.

(2) INDOOR DESIGN TEMPERATURES. Unheated, non-habitable basement areas shall use a heating design temperature of less than 50°F. All other areas of a dwelling shall use a heating design temperature of 70°F.

(3) EQUIPMENT SIZING. Heating design loads including ventilation loads for the purpose of sizing systems shall be determined in accordance with the REScheck or REM/RATE software programs or one of the procedures described in Chapter 29 of ASHRAE Handbook of Fundamentals.

Note: Residential heat balance, residential load factor, Canadian F280 and ACCA Manual J are among the methods recognized as equipment sizing protocols under chapter 29.

Comm 22.41 Temperature control. (1) GENERAL. Each system shall be provided with an adjustable thermostat for the regulation of temperature.

(2) CIRCULATING HOT WATER SYSTEMS. Circulating hot water systems shall include an automatic or readily accessible manual switch to turn off the circulating pump when the system is not in use.

(3) MERCURY THERMOSTATS. The installation of thermostats containing mercury is prohibited.

Note: This section does not require the replacement of existing mercury-containing thermostats.

(4) HEAT PUMP SUPPLEMENTARY HEAT. Heat pumps having supplementary electric-resistance heat shall have controls that, except during defrost, prevent supplemental heat operation when the heat pump compressor can meet the heating load.

Comm 22.42 Duct systems. (1) Supply and return heating ducts, or portions thereof, that are not located completely within the thermal envelope, shall be provided with insulation with a thermal resistance of at least R-8.

(2) Building framing cavities may not be used as supply ducts.

Comm 22.43 Duct and plenum sealing. (1) Duct systems with joints not located entirely within the conditioned space or with joints located on the unconditioned side of stud bays, joist cavities and similar spaces, shall be sealed in accordance with this section.

(2) Sealing shall be accomplished using welds, gaskets, mastics, mastic-plus-embedded-fabric systems or tapes installed in accordance with the manufacturer's instructions.

(3) Insulation that provides a continuous air barrier may be used in lieu of sealing metal ducts.

(4) Tapes and mastics used with rigid fibrous glass ducts shall be listed and labeled as complying with UL 181A.

(5) Tapes and mastics used with flexible air ducts shall be listed and labeled as complying with UL 181B.

(6) Tapes with rubber-based adhesives may not be used.

Note: Standard duct tape or "duck tape" has a rubber-based adhesive and does not comply with the requirements of this section.

Comm 22.44 Pipe insulation. Heating pipes in unheated spaces shall be insulated with material providing a minimum thermal resistance of R-4 as measured on a flat surface in accordance with ASTM standard C 335 at a mean temperature of 75°F.

Comm 22.45 Air conditioner and heat pump efficiencies. (1) Heating and cooling equipment shall meet the minimum efficiency requirements in Table 22.45 when tested and rated in accordance with the applicable test procedure.

(2) The efficiency shall be verified through certification under an approved certification program or, if no certification program exists, the equipment efficiency ratings shall be supported by data furnished by the manufacturer.

(3) Where multiple rating conditions or performance requirements are provided, the equipment shall satisfy all efficiency requirements under this chapter.

(4) Where components, such as indoor or outdoor coils, from different manufacturers are used, calculations and supporting data shall be furnished by the designer that demonstrate that the combined efficiency of the specified components meets the requirements under this section.

Comm 22.46 Replacement furnace and boiler efficiencies. (1) A replacement furnace in existing construction may meet only the prevailing federal efficiency standard provided the duct distribution system is sealed and tested at 0.02 inches water gage across the entire system, including the manufacturer's air handler enclosure, to have air leakage less than ten percent of the furnace manufacturer's rated air flow across the blower at high speed.

Note: 0.02 inches water gage is equal to approximately 25 pascals.

(2) A replacement boiler in existing construction may meet only the prevailing federal standard provided there is no installed circulation pump larger than one-twentieth horsepower and no circulation pump runs continuously.

**TABLE 22.45
UNITARY AIR CONDITIONERS AND CONDENSING UNITS
AND UNITARY AND APPLIED HEAT PUMPS,
ELECTRICALLY OPERATED, MINIMUM EFFICIENCY REQUIREMENTS**

Equipment Type	Minimum efficiency	Minimum efficiency	Test Procedure
Split system and single package air conditioner, air cooled	13.0 SEER		ARI 210/240
Space constrained product-air conditioner	12 SEER		ARI 210/240
Through-the-wall air conditioner, air cooled, split system	10.9 SEER (before Jan. 23, 2010) 12.0 SEER (as of Jan. 23, 2010)		ARI 210/240
Through-the-wall air conditioner, air cooled, single package	10.6 SEER (before Jan. 23, 2010) 12.0 SEER (as of Jan. 23, 2010)		ARI 210/240
Split system and single package air conditioner, Water and evaporatively cooled	12.1 EER		ARI 210/240
Split system and single package heat pump, air cooled	13.0 SEER	7.7 HSPF	ARI 210/240
Through-the-wall air conditioner and heat pump-split system	10.9 SEER (before Jan. 23, 2010) 12.0 SEER (as of Jan. 23, 2010)	7.1 HSPF (before Jan. 23, 2010) 7.4 (as of Jan. 23, 2010)	ARI 210/240
Through-the-wall air conditioners and heat pumps-single package	10.6 SEER (before Jan. 23, 2010) 12.0 SEER (as of Jan. 23, 2010)	7.0 HSPF (before Jan. 23, 2010) 7.4 (as of Jan. 23, 2010)	ARI 210/240
Space constrained products-heat pumps	12 SEER	7.4 HSPF	ARI 210/240
Water source, heating mode, 68 degree F entering water		4.2 COP	ARI/ASHRAE 13256-1
Groundwater source, heating mode, 50 degree F entering water		3.6 COP	ARI/ASHRAE 13256-1
Ground Source, heating mode, 32 degree F entering water		3.1 COP	ARI/ASHRAE 13256-1

Subchapter VI – Simulated Performance Alternative

Comm 22.50 General. This subchapter establishes criteria for compliance using simulated energy performance analysis. The analysis shall include heating, cooling, and service water heating energy only.

Comm 22.51 Performance-based compliance. Compliance based on simulated energy performance requires that a proposed dwelling be shown to have an annual energy cost that is less than or equal to the annual energy cost of the standard reference design.

Comm 22.52 Documentation. (1) COMPLIANCE SOFTWARE TOOLS. Documentation verifying that the methods and accuracy of the compliance software tools conform to the provisions of this subchapter shall be provided to the inspector.

(2) COMPLIANCE REPORT. Compliance software tools shall generate a report that documents that the proposed design has annual energy costs less than or equal to the annual energy costs of the standard reference design. The compliance documentation shall include all of the following information:

(a) Address of the dwelling.

(b) 1. An inspection checklist documenting the building component characteristics of the proposed design as listed in Table 22.53-1.

2. The inspection checklist shall show the estimated annual energy cost for both the standard reference design and the proposed design.

(c) Name of individual completing the compliance report.

(d) Name and version of the compliance software tool.

(3) ADDITIONAL DOCUMENTATION. The inspector may require any of the following documents:

(a) Documentation of the building component characteristics of the standard reference design.

(b) A certification signed by the builder providing the building component characteristics of the proposed design as given in Table 22.53-1.

Comm 22.53 Calculation procedure. (1) GENERAL. Except as specifically allowed under this section, the standard reference design and proposed design shall be configured and analyzed using identical methods and techniques.

(2) REFERENCE AND PROPOSED DESIGNS. The standard reference design and proposed design shall be configured and analyzed as specified by Table 22.53-1. Table 22.53-1 shall include by reference all notes contained in Table 22.31-1.

(3) CALCULATION SOFTWARE TOOLS. Calculation procedures used to comply with this section shall be capable of calculating the annual energy consumption of all building elements that differ between the standard reference design and the proposed design and shall include the following capabilities:

(a) Computer generation of the standard reference design using only the input for the proposed design. The calculation procedure may not allow the user to directly modify the building component characteristics of the standard reference design.

(b) Calculation of whole-building sizing as a single zone for the heating and cooling equipment in the standard reference design residence in accordance with s. Comm 22.40 (3).

(c) Calculations that account for the effects of indoor and outdoor temperatures and part-load ratios on the performance of heating, ventilating and air conditioning equipment based on climate and equipment sizing.

(d) Printed code official inspection checklist listing each of the proposed design component characteristics from Table 22.53 – 1 determined by the analysis to provide compliance, along with their respective performance ratings.

**TABLE 22.53-1
SPECIFICATIONS FOR THE STANDARD REFERENCE AND PROPOSED DESIGNS**

BUILDING COMPONENT	STANDARD REFERENCE DESIGN	PROPOSED DESIGN
Above-grade walls	Type: mass wall if proposed wall is mass; otherwise wood frame Gross area: same as proposed <i>U</i> -Factor: from Table 22.31-2 Solar absorptance = 0.75 Emittance = 0.90	As proposed As proposed As proposed As proposed As proposed
Basement and crawlspace walls	Type: same as proposed Gross area: same as proposed <i>U</i> -Factor: from Table 22.31-2 with insulation layer on interior side of walls	As proposed As proposed As proposed
Above-grade floors	Type: wood frame Gross area: same as proposed <i>U</i> -Factor: from Table 22.31-2	As proposed As proposed As proposed
Ceilings	Type: wood frame Gross area: same as proposed <i>U</i> -Factor: from Table 22.31-2	As proposed As proposed As proposed

Roofs	Type: composition shingle on wood sheathing Gross area: same as proposed Solar absorptance = 0.75 Emittance = 0.90	As proposed As proposed As proposed As proposed
Attics	Type: vented with aperture = 1 ft ² per 300 ft ² ceiling area	As proposed
Foundations	Type: same as proposed	As proposed
Doors	Area: 40 ft ² Orientation: North U-factor: same as fenestration from Table 22.31-2	As proposed As proposed As proposed
Glazing ^a	Total area ^b = (a) The proposed glazing area; where the proposed glazing area is less than 18% of the conditioned floor area (b) 18% of the conditioned floor area; where the proposed glazing area is 18% or more of the conditioned floor area Orientation: equally distributed to four cardinal compass orientations U-factor: from Table 22.31-2 SHGC = 0.40 Interior shade fraction: Summer (all hours when cooling is required) = 0.70 Winter (all hours when heating is required) = 0.85 External shading: none	As proposed As proposed As proposed As proposed Same as standard reference design ^c As proposed
Skylights	U-Factor: from Table 22.31-2	As proposed
Thermally isolated sunrooms	None	As proposed
Air exchange rate	Specific Leakage Area (SLA) ^d = 0.00036 assuming no energy recovery	For residences that are not tested, the same as the standard reference design; For residences without mechanical ventilation that are tested in accordance with ASHRAE 119, Section 5.1, the measured air exchange rate ^e but not less than 0.35 ACH; For residences with mechanical ventilation that are tested in accordance with ASHRAE 119, Section 5.1, the measured air exchange rate ^e combined with the mechanical ventilation rate ^f ,

		<p>which may not be less than $0.01 \times \text{CFA} + 7.5 \times (\text{N br} + 1)$ where: CFA = conditioned floor area N br = number of bedrooms</p>
Mechanical ventilation	<p>None, except where mechanical ventilation is specified by the proposed design, in which case: Annual vent fan energy use: kWh/yr = $0.03942 \times \text{CFA} + 29.565 \times (\text{N br} + 1)$ where: CFA = conditioned floor area N br = number of bedrooms</p>	As proposed
Internal gains	$\text{IGain} = 17,900 + 23.8 \times \text{CFA} + 4104 \times \text{N br}$ (Btu/day per dwelling unit)	Same as standard reference design
Internal mass	An internal mass for furniture and contents of 8 pounds per square foot of floor area	Same as standard reference design, plus any additional mass specifically designed as a thermal storage element ^g but not integral to the building envelope or structure
Structural mass	<p>For masonry floor slabs, 80% of floor area covered by R-2 carpet and pad, and 20% of floor directly exposed to room air; For masonry basement walls, as proposed, but with insulation required by Table 22.31-2 located on the interior side of the walls; For other walls, for ceilings, floors, and interior walls, wood frame construction</p>	<p>As proposed</p> <p>As proposed</p> <p>As proposed</p>
Heating systems ^{h,i}	<p>Fuel type: same as proposed design efficiencies: Electric: air-source heat pump with prevailing federal minimum efficiency; Nonelectric furnaces: natural gas furnace in accordance with Table 22.31-3; Nonelectric boilers: natural gas boiler in accordance with Table 22.31-3; Capacity: sized in accordance with section Comm 22.40 (3)</p>	<p>As proposed</p> <p>As proposed</p> <p>As proposed</p> <p>As proposed</p> <p>As proposed</p>
Cooling systems ^{h,j}	<p>Fuel type: Electric Efficiency: in accordance with prevailing federal minimum standards Capacity: sized in accordance with section Comm 22.40 (3)</p>	<p>As proposed</p> <p>As proposed</p> <p>As proposed</p>

Service Water Heating ^{h, k}	Fuel type: same as proposed design Efficiency: in accordance with prevailing Federal minimum standards Use: gal/day = 30 + 10 × N br Tank temperature: 120°F	As proposed As proposed Same as standard reference Same as standard reference
Thermal distribution systems	A thermal distribution system efficiency (DSE) of 0.80 shall be applied to both the heating and cooling system efficiencies	Same as standard reference design, except as specified by Table 22.53-2
Thermostat	Type: manual, cooling temperature set point = 78°F; heating temperature set point = 68°F	Same as standard reference design

- a Glazing shall be defined as sunlight-transmitting fenestration, including the area of sash, curbing or other framing elements, that enclose conditioned space. Glazing includes the area of sunlight-transmitting fenestration assemblies in walls bounding conditioned basements. For doors where the sunlight-transmitting opening is less than 50% of the door area, the glazing area is the sunlight transmitting opening area. For all other doors, the glazing area is the rough frame opening area for the door including the door and the frame.
- b For residences with conditioned basements, R-2 and R-4 residences and townhouses, the following formula shall be used to determine glazing area: $AF = As \times FA \times F$ where:
1. AF = Total glazing area.
 2. As = Standard reference design total glazing area.
 3. FA = (Above-grade thermal boundary gross wall area)/(above-grade boundary wall area + 0.5 x below-grade boundary wall area).F
 4. F = (Above-grade thermal boundary wall area)/(above-grade thermal boundary wall area + common wall area) or 0.56, whichever is greater. And where:
 5. Thermal boundary wall is any wall that separates conditioned space from unconditioned space or ambient conditions.
 6. Above-grade thermal boundary wall is any thermal boundary wall component not in contact with soil.
 7. Below-grade boundary wall is any thermal boundary wall in soil contact.
 8. Common wall area is the area of walls shared with an adjoining dwelling unit.
- c For fenestrations facing within 15 degrees of true south that are directly coupled to thermal storage mass, the winter interior shade fraction may be increased to 0.95 in the proposed design.
- d Where Leakage Area (L) is defined in accordance with Section 5.1 of ASHRAE 119 and where: $SLA = L/CFA$ where L and CFA are in the same units.
- e Tested envelope leakage shall be determined and documented by an independent party approved by the code official. Hourly calculations as specified in the 2005 ASHRAE Handbook of Fundamentals, Chapter 27, page 27.21, Equation 40, Sherman-Grimsrud model, or the equivalent shall be used to determine the energy loads resulting from infiltration.
- f The combined air exchange rate for infiltration and mechanical ventilation shall be determined in accordance with Equation 43 of 2005 ASHRAE Handbook of Fundamentals page 27.23 and the “Whole-house Ventilation” provisions of 2005 ASHRAE Handbook of Fundamentals, page 27.18 for intermittent mechanical ventilation.
- g Thermal Storage Element means a component not part of the floors, walls or ceilings that is part of a passive solar system, and that provides thermal storage such as enclosed water columns, rock beds, or phase-change containers. A thermal storage element must be in the same room as fenestration that faces within 15 degrees of true south, or must be connected to such a room with pipes or ducts that allow the element to be actively charged.
- h For a proposed design with multiple heating, cooling or water heating systems using different fuel types, the applicable standard reference design system capacities and fuel types shall be weighted in accordance with their respective loads as calculated by accepted engineering practice for each equipment and fuel type present.

- i For a proposed design without a proposed heating system, a heating system of 90% annual fuel utilization shall be assumed for both the standard reference design and proposed design. For electric heating systems, the prevailing federal minimum efficiency air-source heat pump shall be used for the standard reference design.
- j For a proposed design home without a proposed cooling system, an electric air conditioner with the prevailing federal minimum efficiency shall be assumed for both the standard reference design and the proposed design.
- k For a proposed design with a non-storage-type water heater, a 40-gallon storage-type water heater with the prevailing federal minimum energy factor for the same fuel as the predominant heating fuel type shall be assumed. For the case of a proposed design without a proposed water heater, a 40-gallon storage-type water heater with the prevailing federal minimum efficiency for the same fuel as the predominant heating fuel type shall be assumed for both the proposed design and standard reference design.

TABLE 22.53- 2

DEFAULT DISTRIBUTION SYSTEM EFFICIENCIES FOR PROPOSED DESIGNS ^a

DISTRIBUTION SYSTEM CONFIGURATION AND CONDITION:	FORCED AIR SYSTEMS	HYDRONIC SYSTEMS ^b
Distribution system components located in unconditioned space	0.80	0.95
Distribution systems entirely located in conditioned space ^c	0.88	1.00
Proposed “reduced leakage” with entire air distribution system located in the conditioned space ^d	0.96	—
Proposed “reduced leakage” air distribution system with components located in the unconditioned space	0.88	—
Ductless systems ^e	1.00	—

- a Default values given by this table are for untested distribution systems, which must still meet minimum requirements for duct system insulation.
- b Hydronic systems means those systems that distribute heating and cooling energy directly to individual spaces using liquids pumped through closed loop piping and that do not depend on ducted, forced air flows to maintain space temperatures.
- c Entire system in conditioned space means that no component of the distribution system, including the air handler unit, is located outside of the conditioned space.
- d Proposed “reduced leakage” means leakage to outdoors not greater than 3 cfm per 100 ft² of conditioned floor area and total leakage not greater than 9 cfm per 100 ft² of conditioned floor area at a pressure differential of 0.02 inches w.g. across the entire system, including the manufacturer’s air handler enclosure. Total leakage of not greater than 3 cfm per 100 ft² of conditioned floor area at a pressure difference of 0.02 inches w.g. across the entire system, including the manufacturer’s air handler enclosure, shall be deemed to meet this requirement without measurement of leakage to the outdoors. This performance shall be specified as required in the construction documents and confirmed through field-testing of installed systems as documented by an approved independent party.
- e Ductless systems may have forced airflow across a coil but may not have any ducted airflows external to the manufacturer’s air handler enclosure.

SECTION 130. Comm 23.02 (1) (a) is repealed.

SECTION 131. Comm 23.02 (1) (b) and (c) are renumbered Comm 23.02 (1) (a) and (b).

SECTION 132. Comm 23.02 (3) (a) is renumbered Comm 23.02 (3) (a) 1.

SECTION 133. Comm 23.02 (3) (a) 2. is created to read:

Comm 23.02 (3) (a) 2. Automatic or gravity dampers that close when the system is not operating shall be provided for outdoor air intake and exhaust.

SECTION 134. Comm 23.02 (3) (d) is amended to read:

Comm 23.02 (3) (d) *Rooms with toilets, tubs or showers.* ~~Any~~ 1. Except as provided under subd. 2., any room with a toilet, tub or shower shall be provided with exhaust ventilation capable of exhausting 50 cubic feet per minute on an intermittent basis or 20 cubic feet on a continuous basis.

2. For dwellings with no electrical service, any room with a toilet, tub or shower shall be provided with an openable window.

SECTION 135. Comm 23.04 (4) is renumbered Comm 23.04 (6) and Comm 23.04 (1) to (3) are renumbered Comm 23.04 (2) to (4).

SECTION 136. Comm 23.04 (intro.) is renumbered 23.04 (1) and amended to read:

Comm 23.04 (1) GENERAL. (a) All heat producing appliances and cooling appliances shall be listed by a testing agency acceptable to the department.

(b) Installation and maintenance of gas-fueled appliances shall comply with the appliance listing and the requirements of NFPA 54, National Fuel Gas Code, except as otherwise required under this chapter.

(c) The clearances from combustible materials in Tables 23.04-A and 23.04-B shall apply unless otherwise shown on listed appliances.

SECTION 137. Comm 23.04 (5) is created to read:

Comm 23.04 (5) WATER HEATERS USED FOR SPACE HEATING. (a) *Listing.* 1. Water heaters used for space heating shall be listed for such use.

2. The data plate shall indicate that the unit is suitable for simultaneous water heating and space heating.

Note: ANSI Z21.10.1 or ANSI Z 21.10.3 are acceptable listing standards for dual use water heaters.

(b) *Sizing.* A dual use water heater shall be sized to provide sufficient hot water to supply both the daily and hourly peak loads of the dwelling.

(c) *Installation.* Dual use water heaters shall be installed to provide both space heating and potable water.

Note: The Wisconsin Uniform Plumbing Code requires dual use water heaters to be installed by a licensed plumber when installed in a new, not-yet-occupied dwelling. The plumbing code also requires that a floor drain be provided, if the water heater is installed on the lowest floor level and that all piping be suitable for potable water.

(d) *Heat exchanger.* A single-wall heat exchanger may not be used with a toxic heat transfer fluid.

SECTION 138. Comm 23.045 (2) (b) is amended to read:

Comm 23.045 (2) (b) Garages. Solid-fuel-burning appliances may not be installed in a garage unless listed for that application.

SECTION 139. Comm 23.08 (7) is repealed and recreated to read:

Comm 23.08 (7) DUCT SUPPORT. Rigid metal ductwork shall be supported in accordance with Table 23.08-B.

SECTION 140. Comm 23.08, Table 23.08-B is repealed and recreated to read:

**TABLE 23.08-B
DUCT SUPPORTS FOR RIGID DUCTS – 16 GAGE MAXIMUM THICKNESS**

Duct Type	Maximum Size	Duct Position	Hanger Type, Size and Spacing ¹
Circular	10" diam.	Vertical	Strap – one 18 ga. galv. steel x 2" @ 12' o.c.
		Horizontal	Strap - one 22 ga. galv. steel x 1" @ 12' o.c. Rod – one ¼" @ 12' o.c. Wire – one 12 ga. @ 12' o.c.
	18" diam.	Vertical	Strap – one 16 ga. galv. steel x 2" @ 12' o.c.
		Horizontal	Strap - one 22 ga. galv. steel x 1" @ 12' o.c. Rod – one ¼" @ 12' o.c. Wire – one 8 ga. @ 12' o.c.; or Wire – two 12 ga. @ 12' o.c.
Rectangular	60" perim.	Vertical	Strap – one 18 ga. galv. steel x 2" @ 12' o.c.
		Horizontal	Strap – pair ² 22 ga. galv. steel x 1" @ 10' o.c. Rods or Wires – pair ² 10 ga. @ 10' o.c.; or Rods or Wires – pair ² 12 ga. @ 5' o.c.
	144" perim.	Vertical	Strap – one 16 ga. galv. steel x 2" @ 12' o.c.
		Horizontal	Strap – pair ² 18 ga. galv. steel x 1" @ 10' o.c.; or Strap – pair ² 20 ga. galv. steel x 1" @ 8' o.c.; or Strap – pair ² 22 ga. galv. steel x 1" @ 5' o.c. Rods or Wires – pair ² 3/8" @ 10' o.c.; or Rods or Wires – pair ² ¼" @ 8' o.c.

1 These hangers are the minimum required to support the weight of the duct off of the joist, stud or similar structure. The band, wire or strap cradling the duct shall not cause any deformation of the duct.

2 “Pair” means that there are 2 vertical legs. One continuous strap can form both vertical legs.

SECTION 141. Comm 23.09 (1) is amended to read:

Comm 23.09 (1) VOLUME AND BACKDRAFT DAMPERS. (a) Volume duct dampers shall be provided to permit balancing of the system.

(b) Volume dampers shall be provided with access.

Note: Acceptable means of access include: a manufactured access panel, an air grille used as a cover, a plastic ceiling cap or a damper accessible through an air diffuser or grille.

(c) ~~No supply~~ Supply ducts shall ~~may not~~ terminate in a garage ~~without~~ unless a backdraft damper is provided.

END

EFFECTIVE DATE

Pursuant to s. 227.22 (2) (b), Stats., these rules shall take effect on the first day of April, 2009.

CHANGE TO APPENDIX

APPENDIX section 20.04(6) added:

[Note to Revisor: This material should be the very first page of the appendix.]

Normally, for 3 or more attached dwelling units, the Commercial Building Code (CBC) applies. Attached means some construction (other than footings and their bearing material) is shared by the units.

Where 3 or more adjacent but unattached dwelling units are each built with the outside walls that comply with the Uniform Dwelling Code (UDC), the UDC applies throughout and the CBC does *not* apply, even if those outside walls are adjacent to or adjoin each other. If flashing is added over the top of two such adjoining walls, the UDC would still apply.

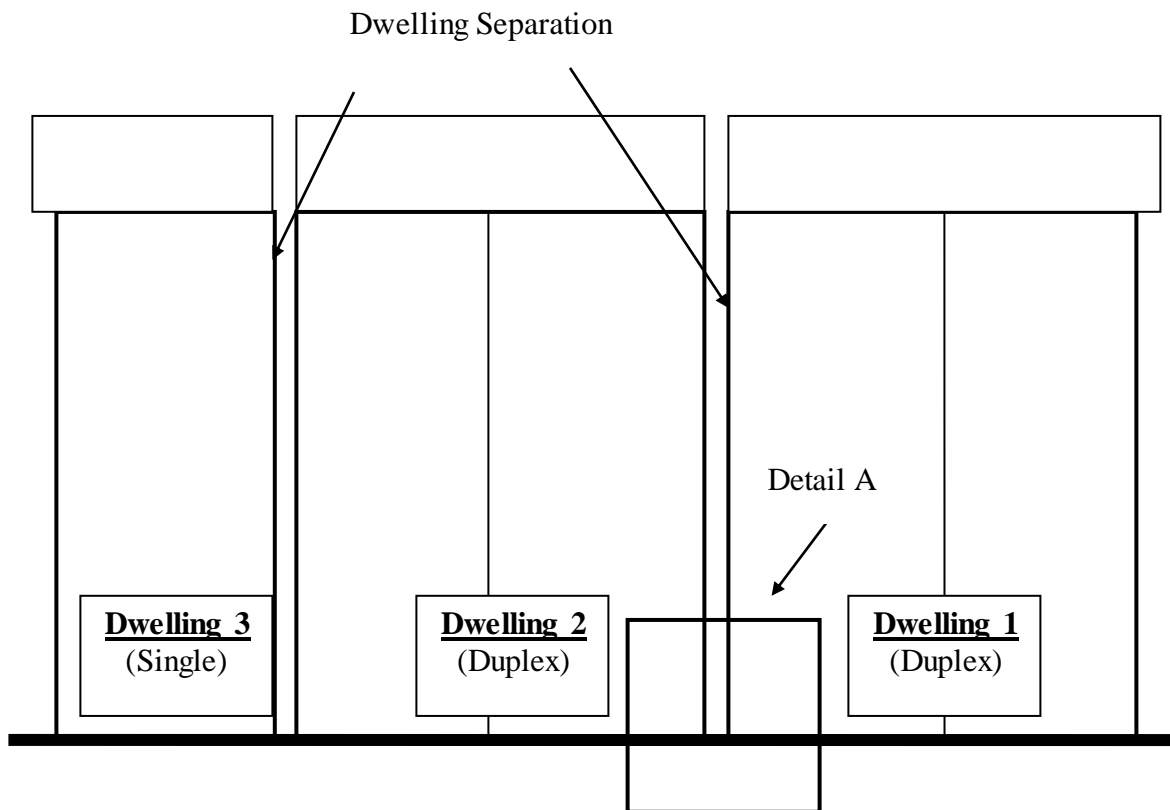

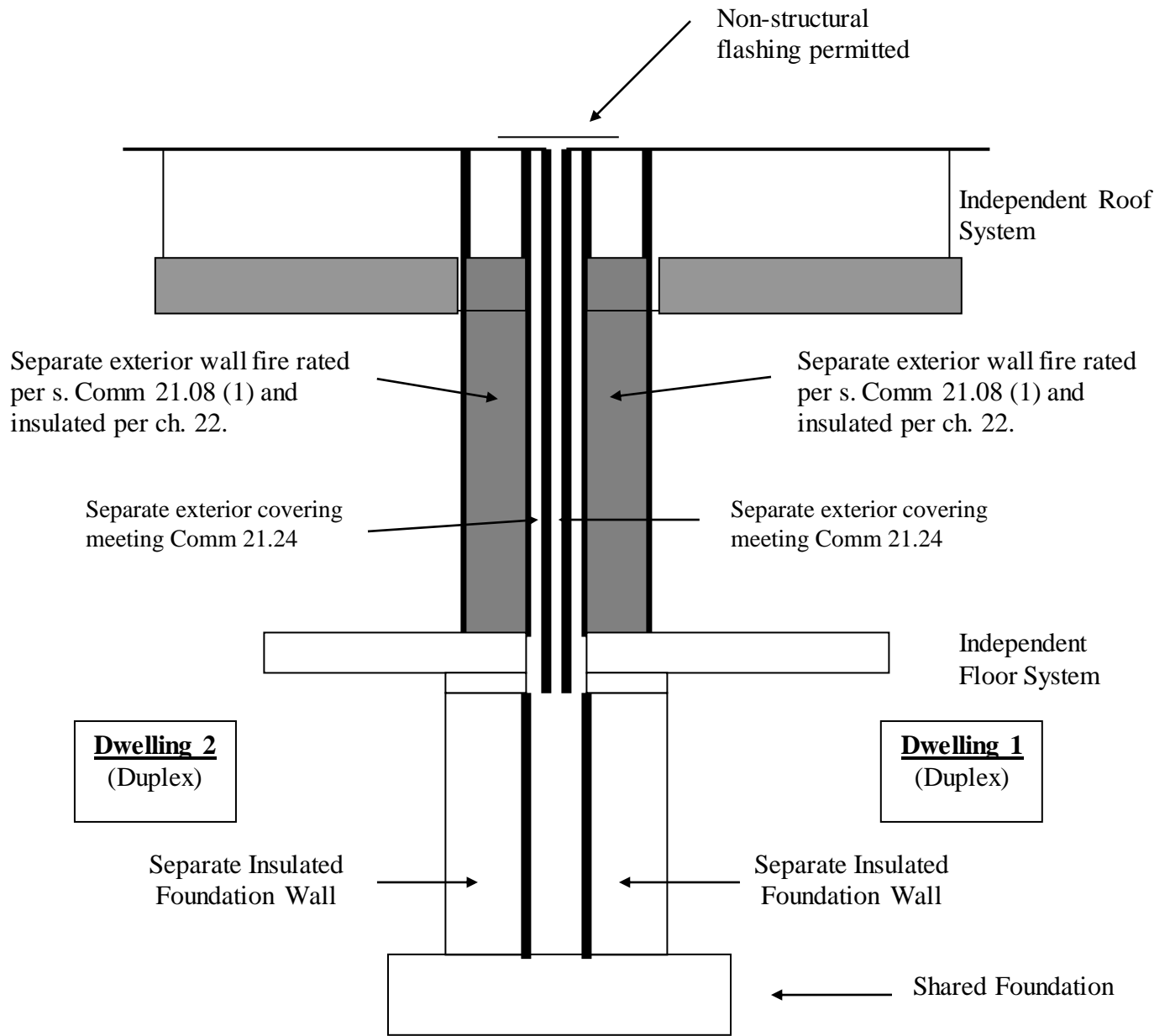

Detail A

APPENDIX Minimum Fastener Schedule Table (current page 89) is repealed and recreated to read:

MINIMUM FASTENER SCHEDULE TABLE
Other interior and exterior panel products and finishes installed per manufacturer requirements.

For engineered connectors, use manufacturer's specified fasteners.

Description of Building Materials/Connection	Number and Type of Fastener^{1 2 3}
Floor Framing	
Joist to joist, face nailed over support	2-12d
Joist to sill or girder, toe nail	2-16d, 3-8d
Band or rim joist to joist, end nail	3-16d
Band or rim joist to sill or top plate	2-16d at 16" o.c.
Bridging to joist, toe nail each end	2-8d
Built-up girder and beams, top loaded	10d at 32" o.c. at top and bottom and staggered and two at ends and at each splice
Built-up girder and beams, side-loaded	16d at 16" o.c. at top and bottom and staggered and two at ends and at each splice
Ledger strip to beam, face nail	3-16d each joist
Joist on ledger to beam, toe nail	3-8d
Wall Framing	
Sole plate to joist or blocking, face nail	16d at 16" o.c.
Top or sole plate to stud, end nail	2-16d
Stud to sole plate, toe nail	4-8d or 3-16d
Doubled studs, face nail	16d at 24" o.c.
Doubled top plates, face nail	16d at 16" o.c.
Top plates, laps and intersections, face nail	2-16d
Continuous header, two pieces	16d at 16" o.c. along each edge
Continuous header to stud, toe nail	4-8d
1" corner brace to each stud and plate, face nail	2-8d or 2 staples, 1 3/4"
Built-up corner studs	16d at 30" o.c., 16d at 24" o.c.
Roof/Ceiling Framing	
Ceiling joists to plate, toe nail	2-16d, 3-8d
Ceiling joist, laps over partitions, face nail	3-16d
Ceiling joist to parallel rafters, face nail	3-16d
Rafter to plate, toe nail (maximum 6' rafter span, engineered connector for longer)	2-16d, 3-8d
Roof rafters to ridge, valley or hip rafters, toe nail	4-16d

Roof rafters to ridge, valley or hip rafters, face nail	3-16d
Collar ties to rafters, face nail	3-8d

Boards and planks

1" x 6" subfloor or less to each joist, face nail	2-8d or 2 staples, 1 3/4"
Wider than 1" x 6" subfloor toe to each joist, face nail	3-8d or 4 staples 1 3/4"
2" subfloor to joist or girder, blind and face nail	2-16d
1" x 6" roof or wall sheathing to each bearing, face nail	2-8d or 2 staples, 1 3/4"
1" x 8" roof or wall sheathing to each bearing, face nail	2-8d or 3 staples, 1 3/4"
Wider than 1" x 8" roof sheathing to each bearing, face nail	3-8d or 4 staples, 1 3/4"
2" planks	2-16d at each bearing

Panel Sheathing

Material	Fastener	Spacing of Fastener	
		Edges	Intermediate Supports
Engineered wood panel for subfloor and roof sheathing and wall corner wind bracing to framing			
5/16-inch to 1/2-inch	6d common or deformed nail or staple, 1 1/2"	6"	12" 4
5/8-inch to 3/4-inch	8d smooth or common, 6d deformed nail, or staple, 14 ga. 1 3/4"	6"	12" 4
7/8-inch to 1-inch	8d common or deformed nail	6"	12"
1 1/8-inch to 1 1/4-inch	10d smooth or common, or 8d deformed nail	6"	12"
Combination subfloor/underlayment to framing			
3/4-inch or less	6d deformed or 8d smooth or common nail	6"	12"
7/8-inch to 1-inch	8d smooth, common or deformed nail	6"	12"
1 1/8-inch to 1 1/4-inch	10d smooth or common or 8d deformed nail	6"	12"
Wood panel siding to framing			
1/2-inch or less	6d corrosion-resistant siding and casing nails	6"	12"
5/8-inch	8d corrosion-resistant siding and casing nails	6"	12"
1/2-inch structural cellulosic fiberboard sheathing	1 1/2" galvanized roofing nail; 8d common nail; staple 16 ga., 1 1/2" long	3"	6"
25/32-inch structural cellulosic fiberboard sheathing	1 3/4" galvanized roofing nail; 8d common nail; staple 16 ga., 1 3/4" long	3"	6"

1/2-inch gypsum sheathing ⁵	1 1/2" galvanized roofing nail; 6d common nail; staple galvanized 1 1/2" long; 1 1/4" screws, Type W or S	4"	8"
5/8-inch gypsum sheathing ⁵	1 3/4" galvanized roofing nail; 8d common nail; staple galvanized 1 5/8" long; 1 5/8" screws, Type W or S	4"	8"

¹All nails are smooth-common, box or deformed shank except where otherwise stated.

²Nail is a general description and may be T-head, modified round head or round head.

³Staples are 16-gauge wire, unless otherwise noted, and have a minimum 7/16-inch o.d. crown width.

⁴Staples shall be spaced at not more than 10 inches o.c. at intermediate supports for floors.

⁵Four-foot-by-8-foot or 4-foot-by-9-foot panels shall be applied vertically

APPENDIX section Comm 21.16, Frost Protected Shallow Footings, (current pages 191 and 192) is repealed.

APPENDIX UDC Energy Worksheet and Associated Tables (current pages 193 to 213) are repealed.

APPENDIX section Comm 21.25 added:

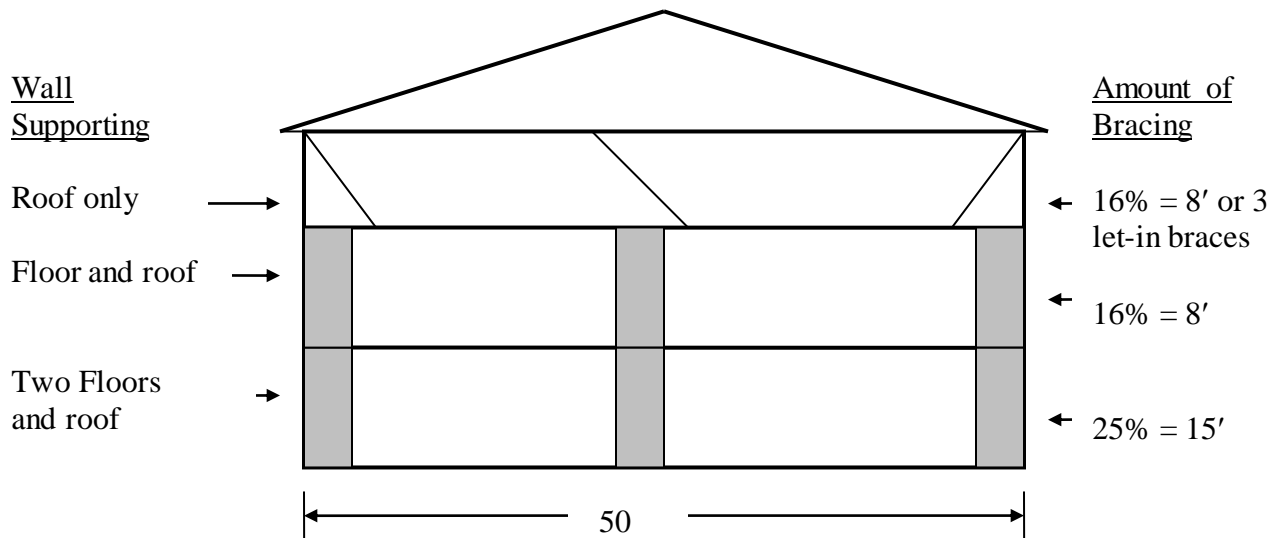

Appendix Fig. 21.25-E
 Wall Bracing Example
 (Wood Panel Sheathing and Let-in Bracing)